

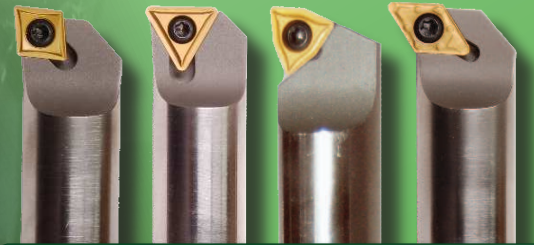

EVEREDE TOOL COMPANY



INSERTS



ANSI BORING BARS

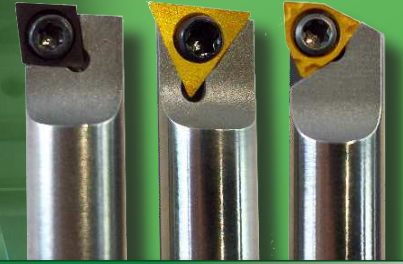

SMALL BORING BARS

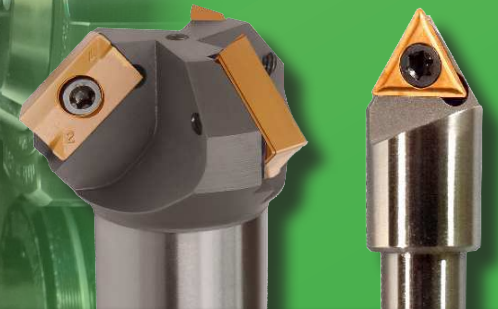

ROTATING TOOLS

Custom Tooling

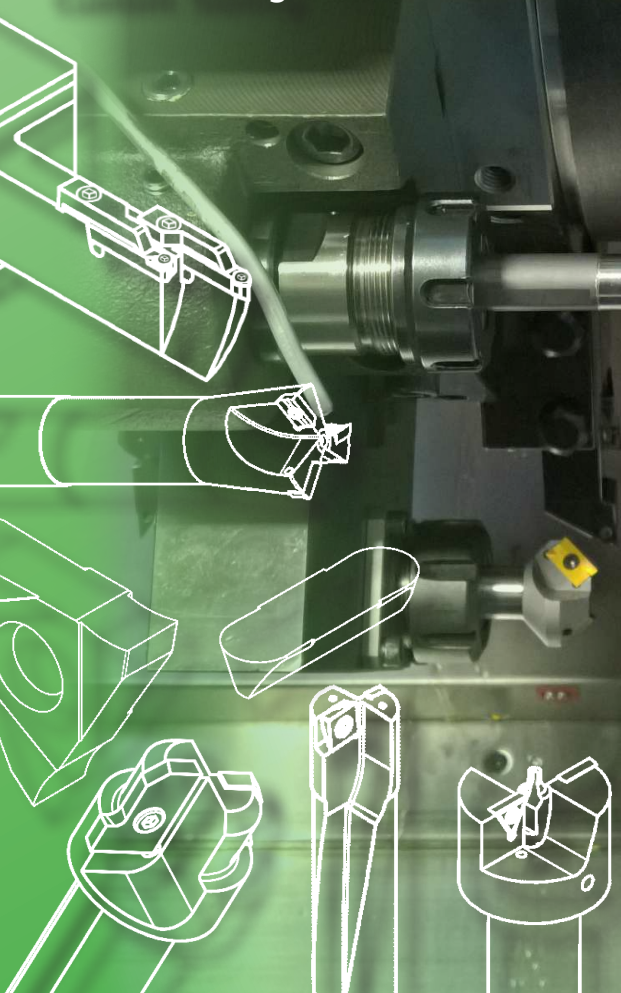

2017





Indexable tooling
since 1932



Indexable spot, engraving,
drilling and boring tools

Everede Tool Company has been
the exclusive U.S.A. representative
since 2002.



Premium Carbide Cutting Tools
Grooving, boring and profiling
starting at Ø 0.2mm

Everede Tool Company has been
the exclusive U.S.A. representative since
2014.

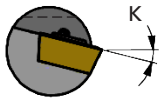

THREE UNIQUE PRODUCT LINES AVAILABLE FROM EVEREDE TOOL COMPANY

RADIAL RAKE ANGLE

BARS WITH FLATS
ANSI & E-H Series

- Bars require a flat for accurate insert center height positioning.
- Minimum insert clearance angles resulting in a stronger cutting edge.
- Can use thicker inserts providing for heavier depth of cuts and increased feed rates.
- Increases radial cutting forces.

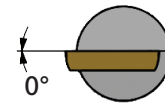

EVEREDE SERIES A-D

- Bars DO NOT require a flat for insert center height positioning.
- 15° & 11° insert clearance angles eliminate need for K angles.
- Inserts are typically thinner.
- Minimal insert offset (F dim.) for smaller Min. bore requirements.
- Decreased Radial Force.

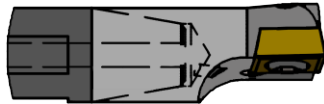
AXIAL RAKE ANGLE

NEUTRAL AXIAL
Bars with "K" angles

- Increased Tangential Force.

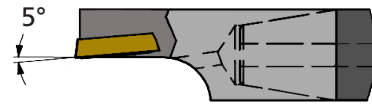

POSITIVE AXIAL
Series A - D

- Improves chip breaking.
- Minimizes tangential cutting forces allowing for deeper Diameter to Length boring depths.
- Decreased Tangential Force.

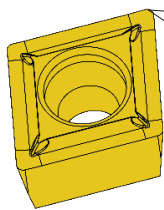
INSERTS: GROUND vs MOULDED / HONED

GROUND

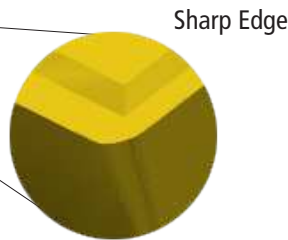

Sharp Edge

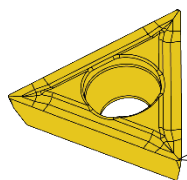

MOULDED / HONED

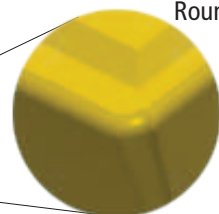

Round Edge

- More precise tolerances provide for better indexability.
- Better surface finish.
- Reduces cutting forces.
- Preferred in high temperature alloy machining.
- All Everede inserts are ground.

- Preferred for roughing and semi-roughing applications in ferrous material.
- Less expensive than ground inserts.
- Stronger edge strength.
- Increases cutting forces.
- Everede CV 6 grade is slightly honed.



CUTTING FORCES

Cutting Forces During Boring Operations

When the tool is cutting, the Tangential and Radial cutting forces will cause the tool to be pushed downward and deflect away from the workpiece.

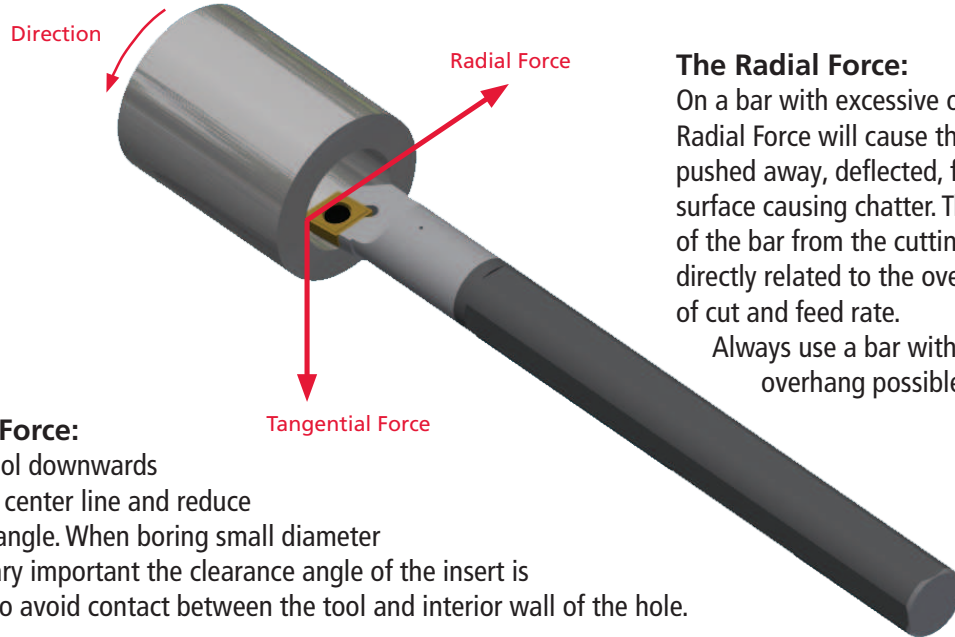

The Radial Force:

On a bar with excessive overhang, the Radial Force will cause the insert to be pushed away, deflected, from the cutting surface causing chatter. The deflection of the bar from the cutting surface is directly related to the overhang, depth of cut and feed rate.

Always use a bar with the shortest overhang possible.







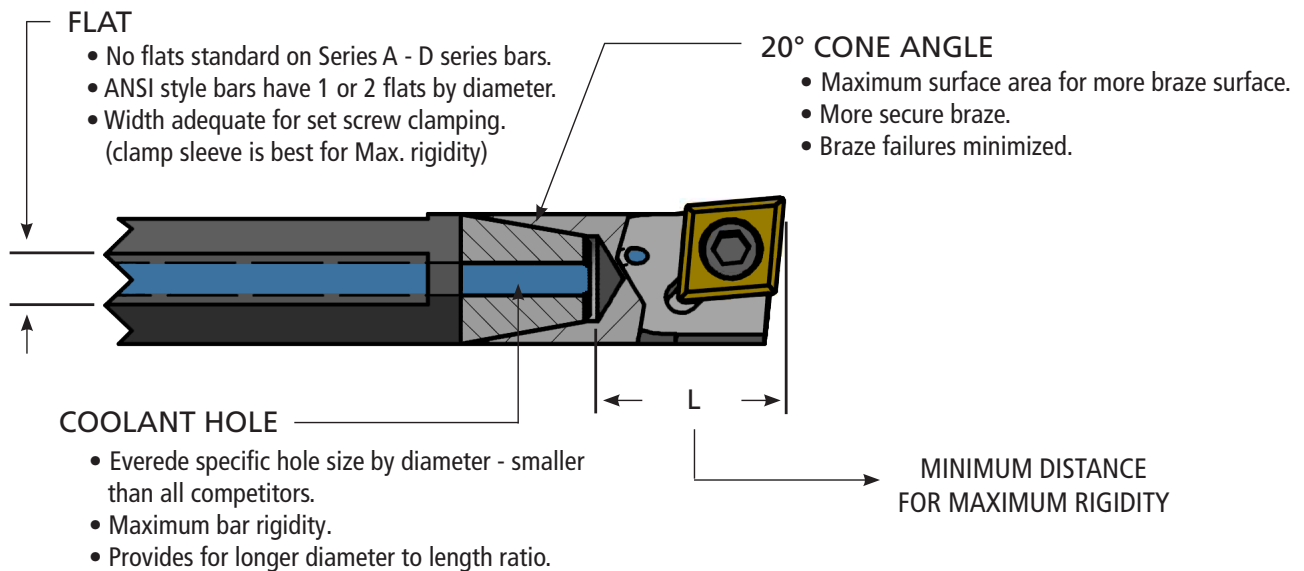







The Tangential Force:

Will displace the tool downwards and away from the center line and reduce the tool clearance angle. When boring small diameter holes, it is particularly important the clearance angle of the insert is sufficient in order to avoid contact between the tool and interior wall of the hole.

CONSTRUCTION BENEFITS





PRODUCT BENEFITS			PAGE
INSERTS			i, ii
INSERTS			2-5
CUTTING DATA			6-13
SETS AND KITS	Boring Bars, Countersinks, Chamfer Mills		14-17
ANSI BORING BARS			18
	ANSI Nomenclature		19
	ANSI Series	MIN BORE RANGE	
	ANSI 7°, 11° & 15° USES CCGT & CPGT INSERTS	 0.180 to 1.200"	20-23
	ANSI 7° USES DCGT INSERTS	 0.600 to 1.500"	24
	ANSI 7° & 11° USES TCGT, TPGT & TPGH INSERTS	 0.270 to 1.200"	25-28
	ANSI 7° USES WCGT INSERTS	 0.230 to 1.200"	29-30
SERIES BORING BARS			
	Ordering Information		31
	Series A	 0.180 to 0.356"	32-34
	Series B-D	 0.270 to 0.360"	35-42
	Series E-H	 0.230 to 1.094"	43-47
	Series FL - Spiral Fluted	 0.220 to 1.000"	48
	Series PB, TH & RCH	 0.272 to 1.205"	49-52
ROTATING TOOLS			
	Series IND - Countersinks	 0.125 to 0.500"	53
	Series CHM - Chamfermills	 0.500 to 1.500"	54
	Series INCB - Counterbores	 0.148 to 1.214"	55
	Series CTPC - Carbide Tipped	 SAE2 -SAE24	56-57
	Cutting Data		58
ACCESSORIES			
	Hardware, Pilots	 59	
	Boring Bar Sleeves	 60	
PRODUCTION STYLE	Boring Bars, Inserts and Part List		61-69
	Bayonet Style		
	Series RSF - Reverse Spot Facers		70
	Series RCS - Reverse Countersinks		
CUSTOM TOOLING			Inside Back Cover

INSERTS

CUTTING DATA

KITS & SETS

ANSI BORING BARS

SERIES BORING BARS

ROTATING TOOLS

INSERTS

EVEREDE PART NO.		EVEREDE GRADES					EVEREDE GRADES										Holder Series			
		IC	T	R	h	ANSI CODE	COATED GRADES					UNCOATED GRADES							CERMET	TIPPED
							PVD	CVD												
CV7	CVM2	TL120	CV6	MC32	CS7	CS6	CM2	CS2	MU12	CT7	PCD	CBN								
APLT-347		.375	.187	.015	.173	APKT 160404	▼	▼	▼			▼		▼				CHM		



CUTTING DATA

EVEREDE PART NO.		EVEREDE GRADES					EVEREDE GRADES										Holder Series			
		IC	T	R	h	ANSI CODE	COATED GRADES					UNCOATED GRADES							CERMET	AM
							PVD	CVD												
CV7	CVM2	TL120	CV6	MC32	CS7	CS6	CM2	CS2	MU12	CT7	PCD	CBN								
CCGT-21.51		.250	.094	.015	.110	CCGT 21.51		▼	▼		▼			▼			CB PC ANSI			
CCGT-32.51		.375	.156	.015	.173	CCGT 32.51		▼	▼		▼			▼			ANSI			
CDCC-07L		.156	.040	.007	.088	CDHH 120605L	▼	▼	▼		▼		▼	▼	▼		A FL ANSI			
CDCC-07R		.156	.040	.007	.088	CDHH 120605R	▼	▼	▼		▼		▼	▼	▼		A FL ANSI			
CDCC-15L		.156	.040	.015	.088	CDHH 12061L	▼	▼	▼		▼		▼	▼	▼		A FL ANSI			
CDCC-15R		.156	.040	.015	.088	CDHH 12061R	▼	▼	▼		▼		▼	▼	▼		A FL ANSI			

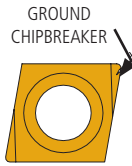

Note: Use left hand ground chipbreaker insert with right hand boring bars. Use right hand ground chipbreaker insert with left hand boring bars.

KITS & SETS

ANSI BORING BARS

SERIES BORING BARS

ROTATING TOOLS

CDGD-02		.156	.040	.002	.088	CDHB 1206X0	▼	▼	▼		▼		▼	▼	▼		A FL ANSI
CDGD-07		.156	.040	.007	.088	CDHB 120605	▼	▼	▼		▼		▼	▼	▼		A FL ANSI
CDGD-15		.156	.040	.015	.088	CDHB 12061	▼	▼	▼		▼		▼	▼	▼		A FL ANSI
CDCH-07		.156	.040	.007	.088	CDHH 120605			▼	▼		▼		▼			A FL ANSI
CDCH-15		.156	.040	.015	.088	CDHH 12061			▼	▼		▼		▼			A FL ANSI
CDCT-02T		.156	.050	.002	.088	N/A				▼				▼			TH
CPGT-21.51		.250	.094	.015	.110	CPGT 21.51			▼	▼		▼		▼			ANSI
CPGT-32.51		.375	.156	.015	.173	CPGT 32.51			▼	▼		▼		▼			ANSI
DCGT-21.51		.250	.094	.015	.110	DCGT 21.51			▼	▼		▼		▼			ANSI
DCGT-32.51		.375	.156	.015	.173	DCGT 32.51			▼	▼		▼		▼			ANSI

Insert ordering Example: APLT-347-TL120. See page 11 for insert grade overview. Ask about our specials and existing inventory of bars *not* featured in our catalogs.

						EVEREDE GRADES											Holder Series		
						COATED GRADES					UNCOATED GRADES					CERMET		TIPPED	
						PVD		CVD								CT7		PCD	CBN
EVEREDE PART NO.	IC	T	R	h	ANSI CODE	CV7	CVM2	TL120	CV6	MC32	CS7	CS6	CM2	CS2	MU12	CT7	PCD	CBN	Holder Series
	TBEB-02F	.160	.047	.002		N/A	▼	▼			▼			▼					TH
	TBEB-04F	.250	.094	.004		N/A		▼	▼			▼	▼	▼					
	TCGT-21.51	.250	.094	.015	.110	TCGT 21.51			▼			▼			▼				ANSI
	TCGT-32.51	.375	.156	.015	.173	TCGT 32.51			▼			▼			▼				
	TDAB-02	.160	.047	.002	.094	TDHB 1308X0	▼	▼	▼	▼	▼		▼	▼	▼	▼	▼	▼	B RCH FL ANSI
	TDAB-07	.160	.047	.007	.094	TDHB 130805	▼	▼	▼	▼	▼		▼	▼	▼	▼	▼	▼	
	TDAB-15	.160	.047	.015	.094	TDHB 13081	▼	▼	▼	▼	▼		▼	▼	▼	▼	▼	▼	
	TDAB-31	.160	.047	.031	.094	TDHB 13082	▼	▼	▼	▼	▼		▼	▼	▼	▼	▼	▼	
	TDAC-07L	.160	.047	.007	.094	TDHH 130805L	▼	▼	▼	▼	▼		▼	▼	▼	▼	▼	▼	B RCH FL ANSI
	TDAC-07R	.160	.047	.007	.094	TDHH 130805R	▼	▼	▼	▼	▼		▼	▼	▼	▼	▼	▼	
	TDAC-15L	.160	.047	.015	.094	TDHH 13081L	▼	▼	▼	▼	▼		▼	▼	▼	▼	▼	▼	
	TDAC-15R	.160	.047	.015	.094	TDHH 13081R	▼	▼	▼	▼	▼		▼	▼	▼	▼	▼	▼	
	TPGB-202	.250	.094	.002	.115	TPGB 21.50		▼	▼	▼		▼	▼	▼	▼				C FL RCH
	TPGB-207	.250	.094	.007	.115	TPGB 21.50.5		▼	▼	▼	▼		▼	▼	▼	▼		▼	
	TPGB-215	.250	.094	.015	.115	TPGB 21.51		▼	▼	▼	▼		▼	▼	▼	▼		▼	
	TPGB-231	.250	.094	.031	.115	TPGB 21.52		▼	▼	▼	▼		▼	▼	▼	▼		▼	
	TPGC-207L	.250	.094	.007	.115	TPGH 21.50.5L		▼	▼	▼	▼		▼	▼	▼	▼			C FL RCH
	TPGC-207R	.250	.094	.007	.115	TPGH 21.50.5R		▼	▼	▼	▼		▼	▼	▼	▼			
	TPGC-215L	.250	.094	.015	.115	TPGH 21.51L		▼	▼	▼	▼		▼	▼	▼	▼			
	TPGC-215R	.250	.094	.015	.115	TPGH 21.51R		▼	▼	▼	▼		▼	▼	▼	▼			
	TPGH-202	.250	.094	.002	.123	TPGH 21.50				▼		▼	▼	▼	▼				C FL CB IND RCH PC ANSI
	TPGH-207	.250	.094	.007	.123	TPGH 21.50.5		▼	▼	▼	▼		▼	▼	▼	▼	○		
	TPGH-215	.250	.094	.015	.123	TPGH 21.51		▼	▼	▼	▼		▼	▼	▼	▼	○		
	TPGH-231	.250	.094	.031	.123	TPGH 21.52		▼	▼	▼	▼		▼	▼	▼	▼	○		

Note: Use left hand ground chipbreaker insert with right hand boring bars. Use right hand ground chipbreaker insert with left hand boring bars.

Note: Use left hand ground chipbreaker insert with right hand boring bars. Use right hand ground chipbreaker insert with left hand boring bars.

○ = outgoing item

Insert ordering example: TBEB-02F-CV7. See page 11 for insert grade overview. Ask about our specials and existing inventory of bars *not* featured in our catalogs.

INSERTS

CUTTING DATA

KITS & SETS

ANSI BORING BARS

SERIES BORING BARS

ROTATING TOOLS

						EVEREDE GRADES										Holder Series		
						COATED GRADES			UNCOATED GRADES					CERMET	TIPPED			
						PVD		CVD										
EVEREDE PART NO.	IC	T	R	h	ANSI CODE	CV7	CVM2	TL120	CV6	MC32	CS7	CS6	CM2	CS2	MU12	CT7	PCD	CBN
TPGB-307	.375	.125	.007	.150	TPGB 320.5	▼	▼	▼	▼	▼		▼	▼	▼	▼		▼	▼
TPGB-315	.375	.125	.015	.150	TPGB 321	▼	▼	▼	▼	▼		▼	▼	▼	▼		▼	▼
TPGB-331	.375	.125	.031	.150	TPGB 322	▼	▼	▼	▼	▼		▼	▼	▼	▼		▼	▼
TPGC-307L	.375	.125	.007	.150	TPGH 320.5L	▼	▼	▼	▼	▼		▼	▼	▼	▼			
TPGC-307R	.375	.125	.007	.150	TPGH 320.5R	▼	▼	▼	▼	▼		▼	▼	▼	▼			
TPGC-315L	.375	.125	.015	.150	TPGH 321L	▼	▼	▼	▼	▼		▼	▼	▼	▼			
TPGC-315R	.375	.125	.015	.150	TPGH 321R	▼	▼	▼	▼	▼		▼	▼	▼	▼			



Note: Use left hand ground chipbreaker insert with right hand boring bars. Use right hand ground chipbreaker insert with left hand boring bars.

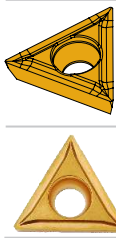



TPGH-307	.375	.125	.007	.173	TPGH 320.5												○	
TPGH-315	.375	.125	.015	.173	TPGH 321	▼	▼	▼	▼	▼		▼	▼	▼	▼		○	
TPGH-331	.375	.125	.031	.173	TPGH 322	▼	▼	▼	▼	▼		▼	▼	▼	▼			
TPGT-32.51	.375	.156	.015	.173	TPGT 32.51			▼	▼			▼			▼			

						EVEREDE GRADES										Holder Series		
						COATED GRADES			UNCOATED GRADES					CERMET	TIPPED			
						PVD		CVD										
EVEREDE PART NO.	IC	T	R	h	ANSI CODE	CV7	CVM2	TL120	CV6	MC32	CS7	CS6	CM2	CS2	MU12	CT7	PCD	CBN
VPGT-207	.250	.125	.007	.110	VPGT 220.5	▼	▼	▼	▼	▼		▼	▼	▼	▼			
VPGT-215	.250	.125	.015	.110	VPGT 221	▼	▼	▼	▼	▼		▼	▼	▼	▼			
VPGT-202L	.250	.125	.002	.110	VPGH 220X0L	▼	▼	▼	▼	▼		▼	▼	▼	▼			
VPGT-202R	.250	.125	.002	.110	VPGH 220X0R	▼	▼	▼	▼	▼		▼	▼	▼	▼			
VPGT-207L	.250	.125	.007	.110	VPGH 220.5L	▼	▼	▼	▼	▼		▼	▼	▼	▼			
VPGT-207R	.250	.125	.007	.110	VPGH 220.5R	▼	▼	▼	▼	▼		▼	▼	▼	▼			
VPGT-215L	.250	.125	.015	.110	VPGH 221L	▼	▼	▼	▼	▼		▼	▼	▼	▼			
VPGT-215R	.250	.125	.015	.110	VPGH 221R	▼	▼	▼	▼	▼		▼	▼	▼	▼			

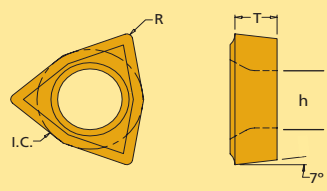
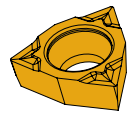
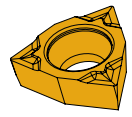
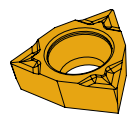
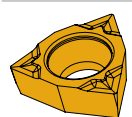

Insert ordering Example: TPGB-307-CVM2. See page 11 for insert grade overview. ○ = outgoing item
Ask about our specials and existing inventory of bars *not* featured in our catalogs.

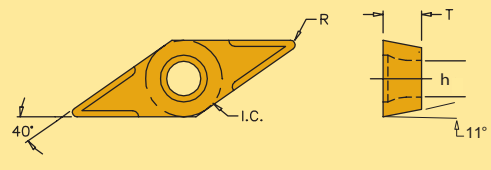
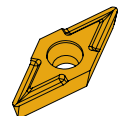
					EVEREDE GRADES											Holder Series		
					COATED GRADES			UNCOATED GRADES					CERMET	TIPPED				
					PVD		CVD							PCD	CBN			
EVEREDE PART NO.	IC	T	R	ANSI CODE	CV7	CVM2	TL120	CV6	MC92	CS7	CS6	CM2	CS2	MU12	GT7	PCD	CBN	
 WCGT-002	.156	.062	.002	WCGT 1.21V5	▼	▼	▼	▼	▼	▼	▼	▼	▼	▼				E FL ANSI
WCGT-008	.156	.062	.008	WCGT 1.210.5	▼	▼	▼	▼	▼	▼	▼	▼	▼	▼				
WCGT-015	.156	.062	.015	WCGT 1.211	▼	▼	▼	▼	▼	▼	▼	▼	▼	▼				
 WCGT-102	.187	.094	.002	WCGT 1.51V5	▼	▼	▼	▼	▼	▼	▼	▼	▼	▼				F FL ANSI
WCGT-108	.187	.094	.008	WCGT 1.51.50.5	▼	▼	▼	▼	▼	▼	▼	▼	▼	▼				
WCGT-115	.187	.094	.015	WCGT 1.51.51	▼	▼	▼	▼	▼	▼	▼	▼	▼	▼				
 WCGT-202	.250	.094	.002	WCGT 21.5V5	▼	▼	▼	▼	▼	▼	▼	▼	▼	▼				G FL PC ANSI
WCGT-208	.250	.094	.008	WCGT 21.50.5	▼	▼	▼	▼	▼	▼	▼	▼	▼	▼				
WCGT-215	.250	.094	.015	WCGT 21.51	▼	▼	▼	▼	▼	▼	▼	▼	▼	▼				
 WCGT-308	.375	.156	.008	WCGT 32.50.5	▼	▼	▼	▼	▼	▼	▼	▼	▼	▼				H FL PC ANSI
WCGT-315	.375	.156	.015	WCGT 32.51	▼	▼	▼	▼	▼	▼	▼	▼	▼	▼				
WCGT-331	.375	.156	.031	WCGT 32.52	▼	▼	▼	▼	▼	▼	▼	▼	▼	▼				

					EVEREDE GRADES											Holder Series		
					COATED GRADES			UNCOATED GRADES					CER	AM				
					PVD		CVD							PCD	CBN			
EVEREDE PART NO.	IC	T	R	ANSI CODE	CV7	CVM2	TL120	CV6	MC92	CS7	CS6	CM2	CS2	MU12	GT7	PCD	CBN	
 XPGT-107	.187	.094	.007	XPGT 1.51.50.5	▼	▼	▼	▼	▼	▼	▼	▼	▼	▼				PB
XPGT-115	.187	.094	.015	XPGT 1.51.51	▼	▼	▼	▼	▼	▼	▼	▼	▼	▼				
 XPGT-102L	.187	.096	.002	XPGH 4.51.5X0L	▼	▼	▼	▼	▼	▼	▼	▼	▼	▼				PB
XPGT-102R	.187	.096	.002	XPGH 4.51.5X0R	▼	▼	▼	▼	▼	▼	▼	▼	▼	▼				
XPGT-107L	.187	.096	.007	XPGH 1.51.50.5L	▼	▼	▼	▼	▼	▼	▼	▼	▼	▼				
XPGT-107R	.187	.096	.007	XPGH 1.51.50.5R	▼	▼	▼	▼	▼	▼	▼	▼	▼	▼				
XPGT-115L	.187	.096	.015	XPGH 1.51.51L	▼	▼	▼	▼	▼	▼	▼	▼	▼	▼				
XPGT-115R	.187	.096	.015	XPGH 1.51.51R	▼	▼	▼	▼	▼	▼	▼	▼	▼	▼				

Left hand shown.

When ordering inserts, indicate Everede part number followed by Everede grade. Example: WCGT-002-CV6
 Ask about our specials and existing inventory of bars *not* featured in our catalogs.
 See page 11 for insert grade overview.



Name	Group	Description	Representative Materials
Steels	1	Free machining & low carbon steels (100-225 BHN)	1008, 1010, 1018, 1020, 10L18, 1108, 1117, 1141, 1151, 11L44, 1200 series, 12L14
	2	Medium & high carbon steel (<35 Rc)	1035, 1040, 1045, 1055, 1080, 1085, 1090, 1525, 1541, 1551, 1561, 1572
	3	Alloy steels (<45 Rc)	1300 series, 200 series, 4012, 4023, 4140, 4320, 4422, 5120, E51100, E52100, 6118, 6150, 7000 series, 8620, 8622, 8640, 8822, E-9310, Cr-Mo alloys
	4	Case or induction hardened steels	Hardened steels >45 Rc
	5	Tool steels (<45 Rc)	SAE classes A (A2 thru A10), D (D2 thru D7), H (H10 thru H42), M (M1 thru M47), O (O1 thru O7), S (S1 thru S7), T (T1 thru T15); wrought high carbon/ low alloy W1, W2, L2, P1, P6
Stainless Steels	6	Austenitic - moderate to difficult machinability (135/185 BHN)	200 & 300 series, XM-1, XM-5, XM-7, XM-21, CF-8M
	7	Martensitic - free cutting (180-220 BHN)	400 & 500 series
	8	Wrought precipitation hardened (32-35 Rc)	13-8Mo, 15-5PH, 17-4PH, 17-7PH
Cast Iron	9	Gray cast iron - low to medium hardness	A48 class 20, 25, 30, 35, 40, 45, 50, 55, 60; J431 grade G1800, G3000, G3500, G4000
	10	Nodular cast iron - medium hardness	A439-62, A467-67, A536 60-40-18, 65-45-12, 80-55-06, 100-70-03, J434, D4512
	11a	Hardened cast iron (48-65 Rc)	Chilled cast iron, high-chrome white cast iron
	11b	Pearlitic gray iron	Pearlitic gray iron
High-Temp High-Strength	12	Nickel & iron based superalloys (<48 Rc)	Inconel, Hastelloy, Waspalloy, Astroloy, Rene, Monel
	13	Cobalt based superalloys (<45 Rc)	AiResist 213, Stellite, Haynes 25 (L605), Haynes 188
	14	Titanium based alloys	Ti98.8, Ti99.9; tungsten, tantalum, zirconium
Non-Ferrous Alloys	15	Free machining	Low silicon aluminum 2024-T4, 2014-T6, 6061-T6, 2011-T3; brass, silver, platinum, gold
	16	Non-free machining	High silicon aluminum A380, A390, Duraclan, Ampco bronze, aluminum castings, aluminum bronze, copper alloys
Non-Metallics	17	Easy to difficult to machine non-metallics	Plastics, graphite, nylon, PVC, Kevlar, "green" ceramics & carbide

INSERTS

CUTTING DATA

KITS & SETS

ANSI BORING BARS

SERIES BORING BARS

ROTATING TOOLS



	Material Group	Description	Roughing	Semi-Finish	Finish
Steel	1	Free machining & low carbon steels (100-225 BHN)	CV6	CV6/TL120	CV6/CV7/TL120
Steel	2	Medium & high carbon steel (<35 Rc)	CV6	CV6/TL120	CV6/CV7/TL120
Steel	3	Alloy steels (<45 Rc)	CV6	CV6/TL120	CV6/CV7/TL120
Steel Hardened	4	Case or induction hardened steels	CBN	CBN	CBN
Tool Steel	5	Tool steels (<45 Rc)	MC32	MC32/TL120	TL120
Stainless Steel - 200/300 Series	6	Austenitic - moderate to difficult machinability (135/185 BHN)	MC32	MC32	CVM2
Stainless Steel - 400/500 PH Series	7	Martensitic - free cutting (180-220 BHN)	TL120	TL120	CVM2
Stainless Steel - 400/500 PH Series	8	Wrought precipitation hardened (32-35 Rc)	TL120	TL120	CVM2
Cast Iron - Gray/Nodular	9	Gray cast iron - low to medium hardness	TL120	TL120	TL120
Cast Iron - Gray/Nodular	10	Nodular cast iron - medium hardness	TL120	TL120	TL120
Cast Iron - Hardened	11a	Hardened cast iron (48-65 Rc)	CBN	CBN	CBN
Cast Iron - Pearlitic	11b	Pearlitic gray iron	CBN	CBN	CBN
High-Temp High-Strength Alloys	12	Nickel & iron based superalloys (<48 Rc)	MC32	TL120	TL120
High-Temp High-Strength Alloys	13	Cobalt based superalloys (<45 Rc)	MC32	TL120	TL120
High-Temp High-Strength Alloys	14	Titanium based alloys	MC32	TL120	TL120
Non-Ferrous Alloys	15	Free machining	CS2	CS2	PCD
Non-Ferrous Alloys	16	Non-free machining	CS2	CS2	PCD
Non-Metallics	17	Easy to difficult to machine non-metallics	CS2	CS2	PCD

NOTES

The recommended maximum depth of cut will exceed the desired operating depth of cut in many situations. Some parameters and guidelines are listed below.

- Finishing passes will typically require significantly lighter depths of cut than general purpose or roughing cuts. For example, a finishing pass using a TDAB style insert in aluminum may require reducing the depth of cut to no more than .005".
- Nose radius needs to be considered in determining maximum depth of cut. For many materials, the depth of cut should not exceed the corner radius when the corner radius is less than .015". For example, in most grades of stainless steel, the depth of cut should not exceed .007" when using a .007" corner radius insert.
- Ground Chipbreakers are recommended for use with stringy materials, light cuts and applications that require a fine finish.
- The accompanying speed and feed charts are meant to provide an appropriate operating range for an array of applications. In roughing applications the recommended speed will be toward the lower end of the range and the feed will be toward the higher end of the range. In finishing applications the recommended speed will be toward the higher end of the range and the feed will be toward the lower end of the range.
- For ANSI program, substitute TL120 grade in material groups 15 and 16.





Material Group	Description	ISO Code	Grade	Cutting Speeds (SFM)		
				Roughing	Semi-finishing	Finishing
1	Free machining & low carbon steels (100-225 BHN)	P05	CT7	*	*	400-1000
		P05	CV7	*	*	500-900
		K30	TL120	300-600	*	*
		P30	CV6	300-500	350-700	*
		K30	MC32	*	150-350	*
		P05	CS7	*	*	300-450
		P30	CS6	*	150-350	*
2	Medium & high carbon steel (<35 Rc)	P05	CT7	*	*	400-1000
		P05	CV7	*	*	500-900
		K30	TL120	300-600	*	*
		P30	CV6	300-500	350-700	*
		K30	MC32	*	150-350	*
		P05	CS7	*	*	300-450
		P30	CS6	*	150-350	*
3	Alloy steel (<45 Rc)	P05	CT7	*	*	400-1000
		P05	CV7	*	*	500-900
		K30	TL120	300-600	*	*
		P30	CV6	300-500	350-700	*
		K30	MC32	*	150-350	*
		P05	CS7	*	*	300-450
		P30	CS6	*	150-350	*
4	Case or induction hardened steels (>45 Rc)	H10	CBN	200-600	200-600	200-600
5	Tool steels (<45 R)	P05	CT7	*	*	300-500
		P05	CV7	*	*	400-600
		K30	TL120	*	400-600	500-700
		P30	CV6	*	350-450	*
		K30	MC32	100-250	100-250	*
		K30	MU12	80-50	*	*
		P05	CT7	*	*	200-500
6	Austenitic - moderate to difficult machinability (135-185 BHN)	K10	CVM2	*	*	350-500
		K30	TL120	250-400	300-500	400-800
		P30	CV6	*	300-400	*
		K30	MC32	150-350	150-400	*
		K30	MU12	100-250	*	*
		P05	CT7	*	*	200-500
7	Martensitic - free cutting (180-220 BHN)	K10	CVM2	*	*	250-500
		K30	TL120	250-400	300-500	*
		P30	CV6	*	300-400	350-500
		K30	MC32	*	250-400	*
		K30	MU12	75-150	*	*
		P05	CT7	*	*	200-500
8	Wrought precipitation hardened (32-35 Rc)	K10	CVM2	*	*	250-500
		K30	TL120	250-400	300-500	*
		K30	MC32	*	150-300	150-300
		K30	MU12	75-150	*	*
		P05	CT7	*	*	200-500

INSERTS

CUTTING DATA

KITS & SETS

ANSI BORING BARS

SERIES BORING BARS

ROTATING TOOLS



CUTTING SPEED RECOMMENDATIONS

Material Group	Description	ISO Code	Grade	Cutting Speeds (SFM)		
				Roughing	Semi-finishing	Finishing
9	Gray cast iron - low to medium hardness (160-260 BHN)	P05	CT7	*	*	250-650
		K30	TL120	200-800	500-1000	600-1500
		P30	CV6	*	300-500	*
		K30	MC32	150-350	250-400	*
		K10	CM2	*	*	250-650
		K20	CS2	*	100-400	*
		K30	MU12	100-200	*	*
10	Nodular cast iron - medium hardness (140-260 BHN)	K10	CVM2	*	*	350-700
		K30	TL120	200-800	400-900	500-1100
		P30	CV6	200-450	350-500	*
		K30	MC32	200-300	200-400	*
11a	Hardened cast iron (48-65 Rc)	H10	CBN	200-600	200-600	200-600
11b	Pearlitic gray iron (200-240 BHN)	H10	CBN	1500-3000	1500-3000	1500-3000
12	Nickel & iron based superalloys (<48 Rc)	K10	CVM2	*	*	100-200
		K30	TL120	75-100	90-200	100-300
		K30	MC32	60-80	70-150	*
		K10	CM2	*	*	100-130
		K20	CS2	*	70-100	*
		K30	MU12	50-65	*	*
13	Cobalt based superalloys (<45 Rc)	K10	CVM2	*	*	100-200
		K30	TL120	75-100	90-200	100-300
		K30	MC32	60-80	70-150	*
		K10	CM2	*	*	100-130
		K20	CS2	*	70-100	*
		K30	MU12	50-65	*	*
14	Titanium based alloys (110-450 BHN)	K10	CVM2	*	*	100-200
		K30	TL120	75-100	90-200	100-300
		K30	MC32	60-80	70-150	*
		K10	CM2	*	*	100-130
		K20	CS2	*	70-100	*
		K30	MU12	50-65	*	*
15	Free machining	N10	PCD	*	*	1000-10000
		K10	CM2	*	800-1500	1000-2000
		K20	CS2	200-800	600-1000	700-1400
		K30	MU12	100-250	100-400	*
16	Non-free machining	N10	PCD	*	*	1000-10000
		K10	CM2	*	400-800	1000-2000
		K20	CS2	200-600	400-800	*
		K30	MU12	100-400	250-400	*
17	Easy to difficult to machine non-metallics	N10	PCD	*	*	750-1500
		K10	CVM2	*	500-700	700-900
		K10	CM2	*	500-700	700-900
		K20	CS2	250-400	400-600	*

Cutting speeds shown in bold-face type represent first choice grade per application for roughing, semi-finish and finishing operations.





INSERTS

CUTTING DATA

KITS & SETS

ANSI BORING BARS

SERIES BORING BARS

ROTATING TOOLS

Series	TURNING	Steel		Tool Steel		Stainless Steel		Cast Iron		High-Temp High-Strength Alloys		Non-Ferrous Alloys		
		DOC	IPR	DOC	IPR	DOC	IPR	DOC	IPR	DOC	IPR	DOC	IPR	
A	CDCD, CDCC or CDCH	FINISH	.008"	.001-.007"	.007"	.002-.005"	.007"	.002-.005"	.007"	.002-.005"	.007"	.002-.005"	.007"	.002-.005"
B	TDAB or TDAC	FINISH	.007"	.001-.004"	.007"	.002-.005"	.007"	.002-.005"	.007"	.002-.005"	.007"	.002-.005"	.007"	.002-.005"
C	TPGH-2, TPGB-2 or TPGC-2	ROUGH	.020"	.001-.010"	.020"	.001-.010"	.020"	.001-.010"	.030"	.001-.010"	.015"	.001-.007"	.090"	.002-.015"
		FINISH	.007"	.002-.005"	.007"	.002-.005"	.007"	.002-.005"	.007"	.002-.005"	.007"	.002-.004"	.007"	.002-.012"
D	TPGH-3, TPGB-3 or TPGC-3	ROUGH	.090"	.001-.012"	.090"	.001-.012"	.090"	.001-.015"	.100"	.001-.015"	.050"	.001-.009"	.200"	.002-.030"
		FINISH	.007"	.002-.005"	.007"	.002-.005"	.007"	.002-.005"	.007"	.002-.005"	.007"	.002-.004"	.007"	.002-.012"

E	WCGT-0	FINISH	.008"	.001-.007"	.007"	.002-.005"	.007"	.002-.005"	.007"	.002-.005"	.007"	.002-.005"	.007"	.002-.005"
F	WCGT-1	FINISH	.008"	.001-.007"	.007"	.002-.005"	.007"	.002-.005"	.007"	.002-.005"	.007"	.002-.005"	.007"	.002-.005"
G	WCGT-2	ROUGH	.020"	.001-.010"	.020"	.001-.010"	.020"	.001-.010"	.030"	.001-.010"	.015"	.001-.007"	.090"	.002-.015"
		FINISH	.007"	.002-.005"	.007"	.002-.005"	.007"	.002-.005"	.007"	.002-.005"	.007"	.002-.004"	.007"	.002-.012"
H	WCGT-3	ROUGH	.090"	.001-.012"	.090"	.001-.012"	.090"	.001-.015"	.100"	.001-.015"	.050"	.001-.009"	.200"	.002-.030"
		FINISH	.007"	.002-.005"	.007"	.002-.005"	.007"	.002-.005"	.007"	.002-.005"	.007"	.002-.004"	.007"	.002-.012"

ANSI	CCGT 21.51	ROUGH	.020"	.001-.010"	.020"	.001-.010"	.020"	.001-.010"	.030"	.001-.010"	.015"	.001-.007"	.090"	.002-.015"
	CPGT 21.51	FINISH	.007"	.002-.005"	.007"	.002-.005"	.007"	.002-.005"	.007"	.002-.005"	.007"	.002-.004"	.007"	.002-.012"
ANSI	CCGT 32.51	ROUGH	.090"	.001-.012"	.090"	.001-.012"	.090"	.001-.015"	.100"	.001-.015"	.050"	.001-.009"	.200"	.002-.030"
	CPGT 21.51	FINISH	.007"	.002-.005"	.007"	.002-.005"	.007"	.002-.005"	.007"	.002-.005"	.007"	.002-.004"	.007"	.002-.012"
ANSI	DCGT 21.51	ROUGH	.020"	.001-.010"	.020"	.001-.010"	.020"	.001-.010"	.030"	.001-.010"	.015"	.001-.007"	.090"	.002-.015"
		FINISH	.007"	.002-.005"	.007"	.002-.005"	.007"	.002-.005"	.007"	.002-.005"	.007"	.002-.004"	.007"	.002-.012"
ANSI	DCGT 32.51	ROUGH	.090"	.001-.012"	.090"	.001-.012"	.090"	.001-.015"	.100"	.001-.015"	.050"	.001-.009"	.200"	.002-.030"
		FINISH	.007"	.002-.005"	.007"	.002-.005"	.007"	.002-.005"	.007"	.002-.005"	.007"	.002-.004"	.007"	.002-.012"
ANSI	TCGT 21.51	ROUGH	.020"	.001-.010"	.020"	.001-.010"	.020"	.001-.010"	.030"	.001-.010"	.015"	.001-.007"	.090"	.002-.015"
	TPGH 21.51	FINISH	.007"	.002-.005"	.007"	.002-.005"	.007"	.002-.005"	.007"	.002-.005"	.007"	.002-.004"	.007"	.002-.012"
ANSI	TCGT 32.51	ROUGH	.090"	.001-.012"	.090"	.001-.012"	.090"	.001-.015"	.100"	.001-.015"	.050"	.001-.009"	.200"	.002-.030"
	TPGH 32.51	FINISH	.007"	.002-.005"	.007"	.002-.005"	.007"	.002-.005"	.007"	.002-.005"	.007"	.002-.004"	.007"	.002-.012"

As D.O.C. increases...I.P.R. decreases.

D.O.C. on finish passes should be equal to or greater than insert radius for inserts with radii of .002", .007" or .008".

D.O.C. on finish passes should be equal to or greater than 1/2 the insert radius for inserts with radii of .015" or .031".

RPM = (3.82 x SFM)/D SFM = surface ft/min D = bore diameter

Series	MILLING	Steel	Tool Steel	Stainless Steel	Cast Iron	High-Temp High-Strength Alloys	Non-Ferrous Alloys
		IPR	IPR	IPR	IPR	IPR	IPR
CHM	APLT-347	.001-.010"	.001-.010"	.001-.010"	.001-.010"	.001-.007"	.002-.015"
INCB	CCGT 21.51	.001-.012"	.001-.012"	.001-.015"	.001-.015"	.001-.009"	.002-.030"
INCB	TPGH-215	.001-.012"	.001-.012"	.001-.015"	.001-.015"	.001-.009"	.002-.030"
IND	TPGH-215	.001-.012"	.001-.012"	.001-.015"	.001-.015"	.001-.009"	.002-.030"

RPM = (3.82 x SFM)/D SFM = surface ft/min D = working diameter of cutter

IPM (in/min) = IPR (in/rev) x T (# of inserts) x RPM

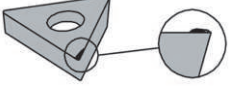
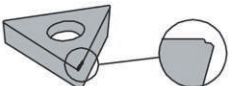
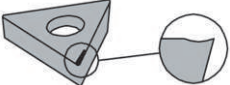
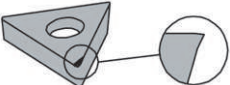
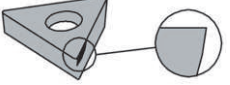
CAUSE AND REMEDY			
BUILT-UP EDGE	DESCRIPTION	CAUSE	REMEDY
	Work piece material is welded to the insert	Low Cutting Speed Geometry Lack of lubricity	Increase cutting speed Use more positive/free cutting insert geometry Enhance lubricity via cutting fluid or insert coating
EDGE CHIPPING			
	Chipping at the cutting edge	Grade too brittle Thermal cracking Built-up edge Breakage Nose radius	Use tougher insert grade Increase coolant supply or use not at all Remedy built-up edge Reduce load on insert Use larger nose radius
CRATER WEAR			
	Wear "crater" on top of insert	Cutting temperature too high Insert grade Geometry	Reduce cutting speed Use AlN coated grade or harder grade of insert Use more positive insert geometry
PLASTIC DEFORMATION			
	Cutting edge is deformed	Cutting temperature too high Insert grade	Reduce cutting speed Use harder grade of insert
FLANK WEAR			
	Cutting edge flank worn	Slow feed Excessive speed Insert grade Clearance	Increase feed Reduce speed Use harder grade or more suitable coated grade Verify insert clearance and increase if necessary
	Poor part surface finish	Nose radius Over feed Material tearing Cutting parameters	Increase insert nose radius Reduce feed rate Use more positive geometry or increase speed Verify correct cutting parameters

CUTTING DATA GRADE OVERVIEW

COATED GRADES	
CV7	PVD TiN/PO5 (gold) coating. Ideal for light finishing steel applications.
CVM2	PVD TiN/K10 (gold) coating. Ideal for stainless steel finishing applications.
TL120	Multi-layer PVD TiAlN/K30 (black) coating. For tool steel, 400/500 & PH series stainless, gray/nodular cast iron and high-temp/high-strength alloys in high heat applications at higher speeds . Works best in dry machining applications.
CV6	Multi-layer CVD TiN/TiC/TiCN/P30 (gold) coating. General purpose steel cutting grade with minimum hone. Works well in low to medium heat applications and at low to medium speeds and feeds.
MC32	Multi-layer CVD TiN/TiC/TiCN/K30 (gold) coating. Excellent lubricity, good wear resistance. Ideal for roughing/semi-finishing of tool steel, 200/300 series stainless steel and high-temp/high strength alloys .
UNCOATED GRADES	
CS7	Micro-grain P05 finishing grade for steel
CS6	Medium grain P30 roughing/semi-finish grade for steel with minimum hone
CM2	Micro-grain K10 semi-finish/finish grade for stainless, cast iron and high-temp/high strength alloys
CS2	Fine grain K20 roughing/semi-finish grade for non-ferrous applications
MU12	Micro-grain K30 roughing grade with high cobalt content for increased toughness
CT7	Cermet P05 steel, stainless and cast iron finishing applications



Everede P/N	ANSI P/N	ISO P/N	I.C.	Thickness	Radius
APLT-347	N/A	APLT 1604PDSR	.375	.187	.015
CCGT 21.51	CCGT 21.51	CCGT 040204	.250	.094	.015
CCGT 32.51	CCGT 32.51	CCGT 06T304	.375	.156	.015
CDCD-02	CDHB-1.20.60	CDHB S4T000	.156	.040	.002
CDCD-07	CDHB-1.20-60.5	CDHB S4T002	.156	.040	.007
CDCD-15	CDHB-1.20.61	CDHB S4T004	.156	.040	.015
CDCH-07	CDHH-1.20-60.5	CDHH S4T002	.156	.040	.007
CDCH-15	CDHH-1.20.61	CDHH S4T004	.156	.040	.015
CPGT 21.51	CPGT 21.51	CPGT 060204	.250	.094	.015
CPGT 32.51	CPGT 32.51	CPGT 09T304	.375	.156	.015
DCGT 21.51	DCGT 21.51	DCGT 070204	.250	.094	.015
DCGT 32.51	DCGT 32.51	DCGT 11T304	.375	.156	.015
TCGT 21.51	TCGT 21.51	TCGT 110204	.250	.094	.015
TCGT 32.51	TCGT 32.51	TCGT 16T304	.375	.156	.015
TDAB-02	TDHB -1.30.80	TDHB 07S100	.160	.047	.002
TDAB-07	TDHB-1.30.80.5	TDHB 07S102	.160	.047	.007
TDAB-15	TDHB-1.30.81	TDHB 07S104	.160	.047	.015
TDAB-31	TDHB-1.30.82	TDHB 07S108	.160	.047	.031
TPGB-202	TPGB 21.50	TPGB 110200	.250	.094	.002
TPGB-207	TPGB-21.50.5	TPGB 110202	.250	.094	.007
TPGB-215	TPGB-21.51	TPGB 110204	.250	.094	.015
TPGB-231	TPGB-21.52	TPGB 110208	.250	.094	.031
TPGB-307	TPGB-320.5	TPGB 160302	.375	.125	.007
TPGB-315	TPGB-321	TPGB 160304	.375	.125	.015
TPGB-331	TPGB-322	TPGB 160308	.375	.125	.031
TPGH-202	TPGH-21.50	TPGH 110200	.250	.094	.002
TPGH-207	TPGH-21.50.5	TPGH 110202	.250	.094	.007
TPGH-215	TPGH-21.51	TPGH 110204	.250	.094	.015
TPGH-231	TPGH-21.52	TPGH 110208	.250	.094	.031
TPGH-307	TPGH-320.5	TPGH 160302	.375	.125	.007
TPGH-315	TPGH-321	TPGH 160304	.375	.125	.015
TPGT-32.51	TPGT-32.51	TPGT 06T304	.375	.156	.015
TPGH-331	TPGH-322	TPGH 160308	.375	.125	.031
VPGT-207	VPGT-220.5	VPGT 110302	.250	.125	.007
VPGT-215	VPGT-221	VPGT 110304	.250	.125	.015
WCGT-002	WCGT-1.21V5	WCGT 0201V5	.156	.062	.002
WCGT-008	WCGT-1.210.5	WCGT 020102	.156	.062	.008
WCGT-015	WCGT-1.211	WCGT 020104	.156	.062	.015
WCGT-102	WCGT-1.51.5V5	WCGT L3020V5	.187	.094	.002
WCGT-108	WCGT-1.51.50.5	WCGT L30202	.187	.094	.008
WCGT-115	WCGT-1.51.51	WCGT L30204	.187	.094	.015
WCGT-202	WCGT-21.5V5	WCGT 04020V5	.250	.094	.002
WCGT-208	WCGT-21.50.5	WCGT 040202	.250	.094	.008
WCGT-215	WCGT-21.51	WCGT 040204	.250	.094	.015
WCGT-308	WCGT-32.50.5	WCGT 06T302	.375	.156	.008
WCGT-315	WCGT-32.51	WCGT 06T304	.375	.156	.015
WCGT-331	WCGT-32.52	WCGT 06T308	.375	.156	.031
XPGT-107	XPGT-1.51.50.5	XPGT L30202	.187	.094	.007
XPGT-115	XPGT-1.51.51	XPGT L30204	.187	.094	.015

INSERTS

CUTTING DATA

KITS & SETS

ANSI BORING BARS

SERIES BORING BARS



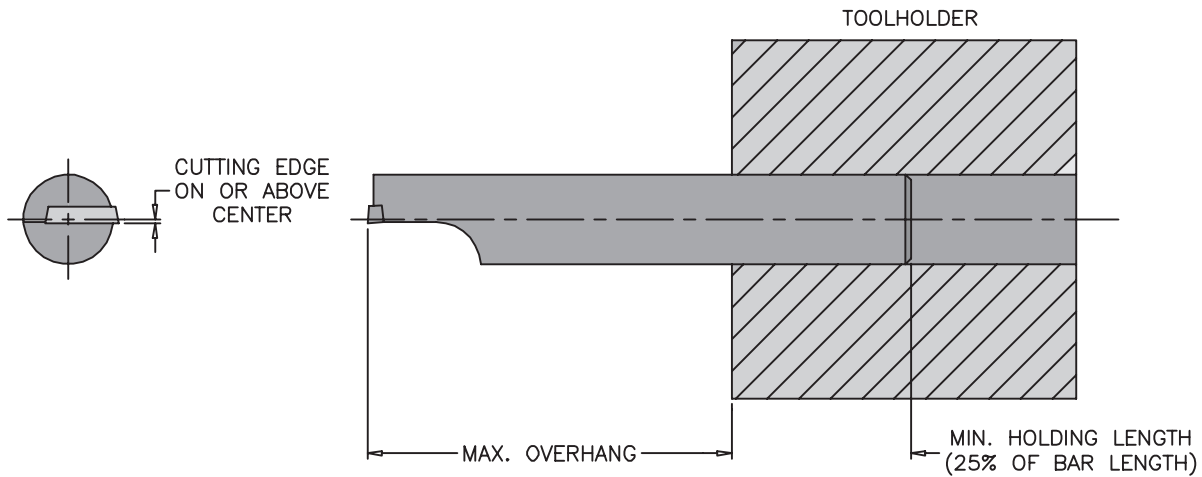

ROTATING TOOLS

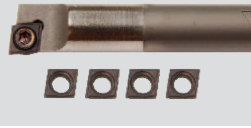

BAR MATERIAL	MAX. OVERHANG
Steel	4 x Bar Dia.
Heavy Metal	7 x Bar Dia.
Carbide	10 x Bar Dia.

CARBIDE GRADE CROSS REFERENCE			
EVEREDE	CIRCLE/WIDIA	KENAMETAL	MITSUBISHI
MU12	CM1	K1	----
CS2	C25	K6	HTi20T
CM2	C3	K68/K313	----
CS6	C50	K420	UTi20T
CS7	C70	K45	----
CT7	TN7	KT125/KT150	AP25N
TL120	ALO	KC935	UE6020
MC32	CG5	KC250	US735
CVM2	----	KC730	UP10H
CV6	CG6	KC850	UE6005
CV7	----	KC740	----
PCD	CPD1	KD100	MD220/MD205
CBN	CBN6	KD120/KD081	MB820/MB810
CBNS	CBN1	KD120/KD081	MB710/MB730

BORING BAR KITS

EVEREDE PART NUMBER	HOLDER	SHANK DIA	OAL	MIN BORE	CONTENTS	
CA1205/TL120 KIT	CA1205	3/16	4	.208	(1) carbide bar (5) CDCH-07-TL120 inserts (1) wrench	
CA1300/TL120 KIT	CA1300	1/4	4	.290		
CA1330/TL120 KIT	CA1330	5/16	6	.356		
CE5215/TL120 KIT	CE5215	3/16	4	.230	(1) carbide bar with flat (5) WCGT-008-TL120 inserts (1) wrench	
CE5300/TL120 KIT	CE5300	1/4	4	.290		
CF6300/TL120 KIT	CF6300	5/16	4	.360	(1) carbide bar with flat (5) WCGT-108-TL120 inserts (1) wrench	
CB1900/TL120 KIT	CB1900	3/16	4	.270	(1) carbide bar (5) TDAB-07-TL120 inserts (1) insert wrench	
CB2200/TL120 KIT	CB2200	1/4	4	.300		
CB2300/TL120 KIT	CB2300	5/16	4	.360		
CC2900/TL120 KIT	CC2900	3/8	6	.438	(1) carbide bar (5) TPGH-215-TL120 (1) insert wrench	
CC3000/TL120 KIT	CC3000	1/2	8	.563		



5° lead angle bars

COUNTERSINK KITS

EVEREDE PART NUMBER	HOLDER	INCLUDED ANGLE	SHANK DIA	CHAMFER RANGE	CONTENTS	
IND-16-8-125/TL120 KIT	IND-16-8-125	82°	3/8	.125-.583	(1) holder (5) TPGH-215-TL120 inserts (1) wrench	
IND-17-8-250/TL120 KIT	IND-17-8-250	82°	1/2	.250-.708		
IND-18-8-375/TL120 KIT	IND-18-8-375	82°	1/2	.375-.833		
IND-16-9-125/TL120 KIT	IND-16-9-125	90°	3/8	.125-.621		
IND-17-9-250/TL120 KIT	IND-17-9-250	90°	1/2	.250-.746		
IND-18-9-375/TL120 KIT	IND-18-9-375	90°	1/2	.375-.871		

Applications: plunge, interpolate and mill

CHAMFERMILL KITS

EVEREDE PART NUMBER	HOLDER	INCLUDED ANGLE	SHANK DIA	CHAMFER RANGE	CONTENTS	
CHM-750-30/ TL120 KIT	CHM-750-30	60°	3/4	.750-1.303	(1) holder (6) APLT-347-TL120 inserts (1) wrench	
CHM-688-41/TL120 KIT	CHM-688-41	82°	3/4	.688-1.414		
CHM-688-45/TL120 KIT	CHM-688-45	90°	3/4	.688-1.471		
CHM-1.000-30/TL120 KIT	CHM-1.000-30	60°	1	1.000-1.553	(1) holder (6) APLT-347-TL120 inserts (1) wrench	
CHM-938-41/TL120 KIT	CHM-938-41	82°	1	.938-1.664		
CHM-938-45/TL120 KIT	CHM-938-45	90°	1	.938-1.721		

• NO SUBSTITUTIONS

Applications: face mill, plunge, interpolate and mill

SERIES A (CDCD INSERTS)
SET 1 - ALLOY STEEL SHANKS

BAR	MINBORE	SHANK
SA1000	.180	.187
SA1005	.208	.187
SA1010	.230	.187
SA1100	.290	.250

SET 1C - CARBIDE SHANKS

BAR	MINBORE	SHANK
CA1200	.180	.156
CA1205	.208	.187
CA1215	.230	.187
CA1300	.290	.250

SET 2 - ALLOY STEEL SHANKS (OVERSIZE 3/8 DIA)

BAR	MINBORE	SHANK
SA1405	.208	.375
SA1420	.230	.375
SA1440	.290	.375

SET 2C - CARBIDE SHANKS

BAR	MINBORE	SHANK
CA1200	.180	.156
CA1215	.230	.187
CA1300	.290	.187

SET 3 - ALLOY STEEL SHANKS (OVERSIZE 1/2 DIA)

BAR	MINBORE	SHANK
SA1605	.208	.500
SA1620	.230	.500
SA1630	.290	.500

SET 5 - ALLOY STEEL SHANKS (STRAIGHT & OVERSIZE)

BAR	MINBORE	SHANK
SA1000	.180	.187
SA1005	.208	.187
SA1420 (oversize shank)	.230	.375
SA1640 (oversize shank)	.290	.500

- Sets 1, 2, 3, 5 come with insert CDCD-07-CVM2.
- Sets 4, 6, 7 come with insert TDAB-07-CVM2.
- See bar catalog pages for more information.
- Straight shank unless noted.
- Lead angle 5°.
- Order by set number.

SETS INCLUDE:

- Boring bars as listed
- (10) inserts as listed below (can be substituted at time of order)
- Steel carrying case (while supplies last)
- Wrenches

SERIES B (TDAB INSERTS)
SET 4 - ALLOY STEEL SHANKS (OVERSIZE 5/8 DIA)

BAR	MINBORE	SHANK
SB2510	.270	.625
SB2530	.300	.625
SB2550	.360	.625

SET 6 - ALLOY STEEL SHANKS

BAR	MINBORE	SHANK
SB1800	.270	.187
SB2000	.300	.250
SB2100	.360	.312

SET 6C - CARBIDE SHANKS

BAR	MINBORE	SHANK
CB1900	.270	.187
CB2200	.300	.250
CB2300	.360	.312

SET 7 - ALLOY STEEL SHANKS (OVERSIZE 1/2 DIA)

BAR	MINBORE	SHANK
SB2410	.270	.500
SB2430	.300	.500
SB2450	.360	.500

SERIES E & F
SET 8 - STRAIGHT SHANKS

BAR	MINBORE	SHANK
SE5010	.230	.187
SE6000	.300	.250
SF6100	.360	.312

SET 8C - CARBIDE SHANKS

BAR	MINBORE	SHANK
CE5215	.230	.187
CE5300	.290	.250
CF6300	.360	.312

SERIES C & D
SET 10
TPGH-2 & TPGH-3 INSERTS

BAR	MINBORE	SHANK
SD3700	1.094	1"
SD3600	.844	3/4"
SD3500	.719	5/8"
SC2800	.563	1/2"
SC2700	.438	3/8"

SERIES G & H
SET 11
WCGT-2 & WCGT-3 INSERTS

BAR	MINBORE	SHANK
SH7700	1.094	1"
SH7600	.844	3/4"
SH7500	.719	5/8"
SG6800	.563	1/2"
SG6700	.438	3/8"

- Sets 8 includes (5) each WCGT-008-CVM2 & WCGT-108-CVM2 inserts.
- Sets 10, 12 include (10) each TPGH-215-CV6 & TPGH-315-CV6 inserts.
- Sets 11, 13 include (10) each WCGT-215-CV6 & WCGT-315-CV6 inserts.
- See bar catalog pages for more bar information.
- Straight shank unless noted.
- Bars have 5° lead angle unless noted.

SETS INCLUDE:

- Boring bars as listed
- Inserts as listed below (can be substituted at time of order)
- Steel carrying case (while supplies last)
- Wrenches

SERIES C & D
SET 12 - 0° LEAD ANGLE
TPGH-2 & TPGH-3 INSERTS

BAR	MINBORE	SHANK
SD3705	1.094	1"
SD3605	.844	3/4"
SD3505	.719	5/8"
SC2805	.563	1/2"
SC2705	.438	3/8"

SERIES G & H
SET 13 - 0° LEAD ANGLE
WCGT-2 & WCGT-3 INSERTS

BAR	MINBORE	SHANK
SH7705	1.094	1"
SH7605	.844	3/4"
SH7505	.719	5/8"
SG6805	.563	1/2"
SG6705	.438	3/8"

SET 60 - 60° included angle		
BODY	MIN. DIA.	MAX. DIA.
IND-15-6-125	.125	.463
IND-16-6-250	.250	.588
IND-17-6-375	.375	.713
IND-18-6-500	.500	.838

SET 82 - 82° included angle		
BODY	MIN. DIA.	MAX. DIA.
IND-16-8-125	.125	.583
IND-17-8-250	.250	.708
IND-18-8-375	.375	.833
IND-19-8-500	.500	.958

SET 90 - 90° included angle		
BODY	MIN. DIA.	MAX. DIA.
IND-16-9-125	.125	.621
IND-17-9-250	.250	.746
IND-18-9-375	.375	.871
IND-11.1-9-500	.500	.996

SET 125 - .125 min. dia.		
BODY	INCLUDED ANGLE	MAX. DIA.
IND-15-6-125	60°	.463
IND-16-8-125	82°	.583
IND-16-9-125	90°	.621

SET 250 - .250 min. dia.		
BODY	INCLUDED ANGLE	MAX. DIA.
IND-16-6-250	60°	.588
IND-17-8-250	82°	.708
IND-17-9-250	90°	.746

SET CHM-30 30° CHAMFER ANGLE (60° included angle)				
	MIN.DIA.	MAX. DIA.	SHANK DIA.	# OF FLUTES
CHM-750-30	.750	1.303	.750	2
CHM-1.000-30	1.000	1.553	1.000	3
CHM-1.250-30	1.250	1.803	1.250	3

SET CHM-41 41° CHAMFER ANGLE (82° included angle)				
	MIN.DIA.	MAX. DIA.	SHANK DIA.	# OF FLUTES
CHM-688-41	.688	1.414	.750	2
CHM-938-41	.938	1.664	1.000	3
CHM-1.188-41	1.188	1.914	1.250	3

SET CHM-45 45° CHAMFER ANGLE (90° included angle)				
	MIN.DIA.	MAX. DIA.	SHANK DIA.	# OF FLUTES
CHM-688-45	.688	1.471	.750	2
CHM-938-45	.938	1.721	1.000	3
CHM-1.188-45	1.188	1.971	1.250	3

SET CHM-60 60° CHAMFER ANGLE (120° included angle)				
	MIN.DIA.	MAX. DIA.	SHANK DIA.	# OF FLUTES
CHM-500-60	.500	1.458	.750	2
CHM-750-60	.750	1.708	1.000	3
CHM-1.000-60	1.000	1.958	1.250	3

SETS INCLUDE:

- All bodies use the same insert. Each set packaged in a handsome metal case (while supplies last) and includes 10 coated inserts (TPGH-215-CV6) and wrenches.
- Inserts are above center for better cutting action.
- Precision ground shanks for true concentricity.
- Order by set number.

SET 375 - .375 min. dia.		
BODY	INCLUDED ANGLE	MAX. DIA.
IND-17-6-375	60°	.713
IND-18-8-375	82°	.833
IND-18-9-375	90°	.871

SET 500 - .500 min. dia.		
BODY	INCLUDED ANGLE	MAX. DIA.
IND-18-6-500	60°	.838
IND-19-8-500	82°	.958
IND-11.1-9-500	90°	.996

CHAMFER MILLS

SETS INCLUDE:

- Can be used for countersinking, chamfer milling and face milling.
- Extra length of cut with parallelogram inserts.
- All holders use the same insert (APLT-347-CV6).
- Sets include three holders and 10 coated inserts and wrenches in a metal box (while supplies last).
- Order by set number.



ANSI BORING BAR PROGRAM

INSERTS

CUTTING DATA

KITS & SETS

ANSI
BORING BARS

SERIES
BORING BARS

ROTATING TOOLS

- **STEEL**
- **STEEL WITH COOLANT THRU**
- **CARBIDE**
- **CARBIDE WITH COOLANT THRU**
- **INSERTS**
- **STUB OAL - CARBIDE & CARBIDE COOLANT THRU**
- **MULTIPLE INSERT I.C. SIZES OFFERED ON 1/2" & 5/8" BARS**

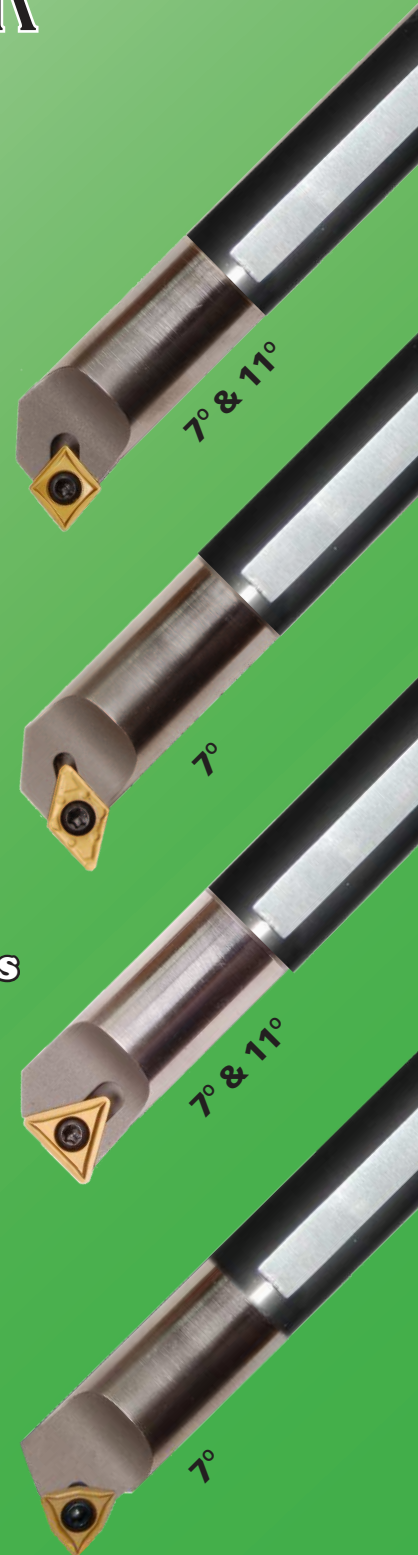

- **LARGE ON-HAND INVENTORY**
- **BEST PRICES IN THE INDUSTRY**
- **FAST DELIVERY**



SHANK DIA		
02.5	.156	(5/32)
03	.187	(3/16)
04	.250	(1/4)
05	.312	(5/16)
06	.375	(3/8)
08	.500	(1/2)
10	.625	(5/8)
12	.750	(3/4)
16	1.000	(1)
20	1.250	(1 1/4)
22	1.375	(1 3/8)
24	1.500	(1 1/2)

SHANK MATERIAL
 A = coolant thru steel
 C = carbide
 E = coolant thru carbide
 J = coolant thru heavy metal
 M = heavy metal
 S = steel

OAL
 E = 2.5
 F = 3
 G = 3.5
 H = 4
 J = 4.5
 K = 5
 M = 6
 Q = 7
 R = 8
 S = 10
 T = 12
 Z = Special Length

HOLDING METHOD
 S = screw

LEAD ANGLE

F = 0°	
L = 5°	
U = 3°	

HAND OF BAR
 R = right
 L = left

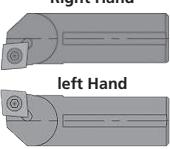

1/4" & under bars do not have flats
 5/16" & 3/8" bars have single flat
 1/2" & over bars have 2 flats

S 10 M - S C L C R - 2

INSERT NOMENCLATURE

INSERT SHAPE

C = 80° diamond	
D = 55° diamond	
T = triangle	
W = trigon	

INSERT CLEARANCE

B = 5°	
C = 7°	
D = 15°	
P = 11°	

INSERT I.C.
 1.2 = .156
 1.3 = .160
 1.5 = .187
 2 = .250
 3 = .375

T C G T - 2 1.5 1

TOLERANCE	I.C.	THICKNESS
A =	+/- .001	+/- .001
C =	+/- .001	+/- .001
E =	+/- .001	+/- .001
F =	+/- .0002 to +/- .0004	+/- .001
G =	+/- .001	+/- .005

CHIPBREAKER/HOLE
 B = flat tip C'Sink hole
 C = ground groove / C'Sink hole
 D = flat top / C'Sink hole
 H = molded / ANSI style hole
 T = molded / ANSI style hole

THICKNESS
 0.6 = .040
 0.8 = .047
 1 = .062
 1.5 = .094
 2 = .125
 2.5 = .156

RADIUS
 V5 = .002
 X0 = .002
 0 = .002
 0.5 = .007/.008
 1 = .015
 2 = .031

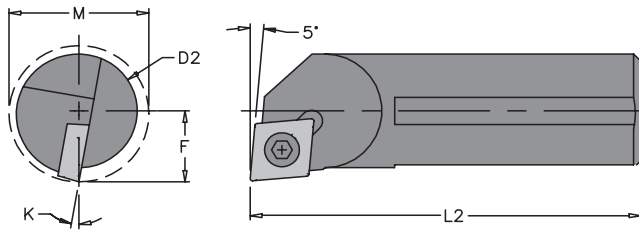

Right hand shown

ALLOY STEEL SHANKS (Series ANSI)

EVEREDE PART NUMBER				K	D2	F	M	L2	INSERTS	LIST PRICE
RIGHT HAND	DS	LEFT HAND	DS	ANGLE	SHANK DIA	DIM	MIN BORE	OAL		
S03E SCLDR-1.2	▼	S03E SCLDL-1.2	○	---	.187	.116	.230	2.5	CDHB 1.20.61	\$44
S04F SCLDR-1.2	▼	S04F SCLDL-1.2	○	---	.250	.145	.290	3		
S05K SCLCR-2	▼	S05K SCLCL-2	○	13	.312	.219	.415	5	CCGT 21.51	\$49
S06M SCLCR-2	▼	S06M SCLCL-2	○	12	.375	.250	.480	6		
S08R SCLCR-2	▼	S08R SCLCL-2	○	12	.500	.312	.600	8	CCGT 32.51	\$55
S08R SCLCR-3	▼	S08R SCLCL-3	○	14	.500	.312	.600	8		
S10S SCLCR-2	▼	S10S SCLCL-2	○	8	.625	.406	.770	10	CCGT 21.51	\$68
S10S SCLCR-3	▼	S10S SCLCL-3	○	11	.625	.406	.770	10	CCGT 32.51	\$84
S12S SCLCR-3	▼	S12S SCLCL-3	○	8	.750	.500	.930	10		
S16T SCLCR-3	▼	S16T SCLCL-3	○	6	1	.640	1.200	12		\$122

ALLOY STEEL SHANKS (Series ANSI) with Coolant Thru

EVEREDE PART NUMBER				K	D2	F	M	L2	INSERTS	LIST PRICE
RIGHT HAND	DS	LEFT HAND	DS	ANGLE	SHANK DIA	DIM	MIN BORE	OAL		
A05K SCLCR-2	○	A05K SCLCL-2	○	13	.312	.219	.415	5	CCGT 21.51	\$60
A06M SCLCR-2	○	A06M SCLCL-2	○	12	.375	.250	.480	6		\$65
A08R SCLCR-2	○	A08R SCLCL-2	○	12	.500	.312	.600	8	CCGT 32.51	\$71
A08R SCLCR-3	○	A08R SCLCL-3	○	14	.500	.312	.600	8		
A10S SCLCR-2	○	A10S SCLCL-2	○	8	.625	.406	.770	10	CCGT 21.51	\$87
A10S SCLCR-3	○	A10S SCLCL-3	○	11	.625	.406	.770	10		
A12S SCLCR-3	○	A12S SCLCL-3	○	8	.750	.500	.930	10	CCGT 32.51	\$102
A16T SCLCR-3	○	A16T SCLCL-3	○	6	1	.640	1.200	12		\$135

CARBIDE SHANKS (Series ANSI) with Alloy Steel Head

EVEREDE PART NUMBER				K	D2	F	M	L2	INSERTS	LIST PRICE
RIGHT HAND	DS	LEFT HAND	DS	ANGLE	SHANK DIA	DIM	MIN BORE	OAL		
C02.5H SCLDR-1.2	▼	C02.5H SCLDL-1.2	○	---	.156	.092	.180	4	CDHB 1.20.61	\$130
C03H SCLDR-1.2	▼	C03H SCLDL-1.2	○	---	.187	.116	.230	4		
C04H SCLDR-1.2	▼	C04H SCLDL-1.2	○	---	.250	.145	.290	4	CCGT 21.51	\$149
C05M SCLCR-2	▼	C05M SCLCL-2	○	13	.312	.219	.415	6		
C06M SCLCR-2	▼	C06M SCLCL-2	○	12	.375	.250	.480	6	CCGT 21.51	\$168
C08J SCLCR-2	▼	C08J SCLCL-2	○	12	.500	.312	.600	4.5		
C08R SCLCR-2	▼	C08R SCLCL-2	○	12	.500	.312	.600	8	CCGT 32.51	\$193
C08J SCLCR-3	▼	C08J SCLCL-3	○	14	.500	.312	.600	4.5		
C08R SCLCR-3	▼	C08R SCLCL-3	○	14	.500	.312	.600	8	CCGT 21.51	\$240
C10Q SCLCR-2	▼	C10Q SCLCL-2	○	8	.625	.406	.770	7		
C10S SCLCR-2	▼	C10S SCLCL-2	○	11	.625	.406	.770	10	CCGT 21.51	\$282
C10Q SCLCR-3	▼	C10Q SCLCL-3	○	11	.625	.406	.770	7		
C10S SCLCR-3	▼	C10S SCLCL-3	○	11	.625	.406	.770	10	CCGT 32.51	\$295
C12Q SCLCR-3	▼	C12Q SCLCL-3	○	8	.750	.500	.930	7		
C12S SCLCR-3	▼	C12S SCLCL-3	○	8	.750	.500	.930	10	CCGT 32.51	\$348
C16R SCLCR-3	▼	C16R SCLCL-3	○	6	1	.640	1.200	8		
C16T SCLCR-3	▼	C16T SCLCL-3	○	6	1	.640	1.200	12		\$612

○ = EXPRESS DELIVERY
▼ = STOCK

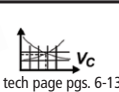

Bars with no "K" angles have no flats.

INSERTS

CUTTING DATA

KITS & SETS

ANSI BORING BARS

SERIES BORING BARS

ROTATING TOOLS

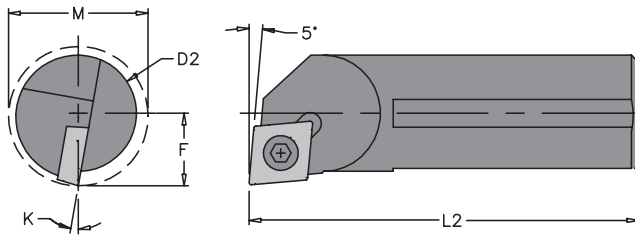

Right hand shown

CARBIDE SHANKS (Series ANSI) with Alloy Steel Head Coolant Thru

EVEREDE PART NUMBER				K	D2	F	M	L2		
RIGHT HAND	DS	LEFT HAND	DS	ANGLE	SHANK DIA	DIM	MIN BORE	OAL	INSERTS	LIST PRICE
E02.5H SCLDR-1.2	▼	E02.5H SCLDL-1.2	○	---	.156	.092	.180	4	CDHB 1.20-60.5	\$146
E03H SCLDR-1.2	▼	E03H SCLDL-1.2	○	---	.187	.116	.230	4		
E04H SCLDR-1.2	▼	E04H SCLDL-1.2	○	---	.250	.145	.290	4		
E05M SCLCR-2	▼	E05M SCLCL-2	○	13	.312	.219	.415	6	CCGT 21.51	\$164
E06M SCLCR-2	▼	E06M SCLCL-2	○	12	.375	.250	.480	6		\$184
E08J SCLCR-2	▼	E08J SCLCL-2	○	14	.500	.312	.600	4.5		\$208
E08R SCLCR-2	▼	E08R SCLCL-2	○	12	.500	.312	.600	8	CCGT 32.51	\$184
E08J SCLCR-3	▼	E08J SCLCL-3	○	14	.500	.312	.600	4.5		\$208
E08R SCLCR-3	▼	E08R SCLCL-3	○	14	.500	.312	.600	8	CCGT 21.51	\$259
E10Q SCLCR-2	▼	E10Q SCLCL-2	○	8	.625	.406	.770	7		\$315
E10S SCLCR-2	▼	E10S SCLCL-2	○	8	.625	.406	.770	10	CCGT 32.51	\$259
E10Q SCLCR-3	▼	E10Q SCLCL-3	○	11	.625	.406	.770	7		\$315
E10S SCLCR-3	▼	E10S SCLCL-3	○	11	.625	.406	.770	10		\$325
E12Q SCLCR-3	▼	E12Q SCLCL-3	○	8	.750	.500	.930	7	CCGT 32.51	\$376
E12S SCLCR-3	▼	E12S SCLCL-3	○	8	.750	.500	.930	10		\$481
E16R SCLCR-3	▼	E16R SCLCL-3	○	6	1	.640	1.200	8	CCGT 32.51	\$612
E16T SCLCR-3	▼	E16T SCLCL-3	○	6	1	.640	1.200	12		

INSERTS

CUTTING DATA

KITS & SETS

ANSI BORING BARS

SERIES BORING BARS

ROTATING TOOLS

○ = EXPRESS DELIVERY ▼ = STOCK	inserts p. 2	screws p. 59	wrenches p. 59	tech page pgs. 6-13	Bars with no "K" angles have no flats.
-----------------------------------	--------------	--------------	----------------	---------------------	--

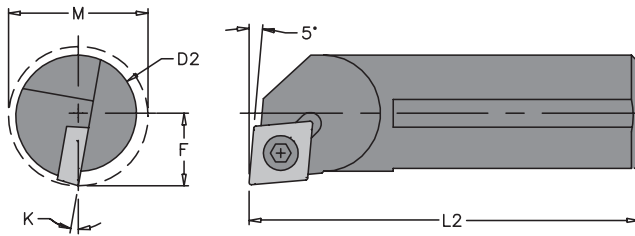

Right hand shown

ALLOY STEEL SHANKS (Series ANSI)

EVEREDE PART NUMBER				K	D2	F	M	L2		
RIGHT HAND	DS	LEFT HAND	DS	ANGLE	SHANK DIA	DIM	MIN BORE	OAL	INSERTS	LIST PRICE
S05K SCLPR-2	▼	S05K SCLPL-2	○	13	.312	.219	.415	5		\$44
S06M SCLPR-2	▼	S06M SCLPL-2	○	12	.375	.250	.480	6	CPGT 21.51	\$49
S08R SCLPR-2	▼	S08R SCLPL-2	○	12	.500	.312	.600	8		\$55
S08R SCLPR-3	▼	S08R SCLPL-3	○	14	.500	.312	.600	8	CPGT 32.51	
S10S SCLPR-2	▼	S10S SCLPL-2	○	8	.625	.406	.770	10	CPGT 21.51	\$68
S10S SCLPR-3	▼	S10S SCLPL-3	○	11	.625	.406	.770	10		
S12S SCLPR-3	▼	S12S SCLPL-3	○	8	.750	.500	.930	10	CPGT 32.51	\$84
S16T SCLPR-3	▼	S16T SCLPL-3	○	6	1	.640	1.200	12		\$122

ALLOY STEEL SHANKS (Series ANSI) with Coolant Thru

EVEREDE PART NUMBER				K	D2	F	M	L2		
RIGHT HAND	DS	LEFT HAND	DS	ANGLE	SHANK DIA	DIM	MIN BORE	OAL	INSERTS	LIST PRICE
A05K SCLPR-2	○	A05K SCLPL-2	○	13	.312	.219	.415	5		\$60
A06M SCLPR-2	○	A06M SCLPL-2	○	12	.375	.250	.480	6	CPGT 21.51	\$65
A08R SCLPR-2	○	A08R SCLPL-2	○	12	.500	.312	.600	8		\$71
A08R SCLPR-3	○	A08R SCLPL-3	○	14	.500	.312	.600	8	CPGT 32.51	
A10S SCLPR-2	○	A10S SCLPL-2	○	8	.625	.406	.770	10	CPGT 21.51	\$87
A10S SCLPR-3	○	A10S SCLPL-3	○	11	.625	.406	.770	10		
A12S SCLPR-3	○	A12S SCLPL-3	○	8	.750	.500	.930	10	CPGT 32.51	\$102
A16T SCLPR-3	○	A16T SCLPL-3	○	6	1	.640	1.200	12		\$135

CARBIDE SHANKS (Series ANSI) with Alloy Steel Head

EVEREDE PART NUMBER				K	D2	F	M	L2		
RIGHT HAND	DS	LEFT HAND	DS	ANGLE	SHANK DIA	DIM	MIN BORE	OAL	INSERTS	LIST PRICE
C05M SCLPR-2	▼	C05M SCLPL-2	○	13	.312	.219	.415	6		\$130
C06M SCLPR-2	▼	C06M SCLPL-2	○	12	.375	.250	.480	6	CPGT 21.51	\$149
C08J SCLPR-2	▼	C08J SCLPL-2	○	12	.500	.312	.600	4.5		\$168
C08R SCLPR-2	▼	C08R SCLPL-2	○	12	.500	.312	.600	8		\$193
C08J SCLPR-3	▼	C08J SCLPL-3	○	14	.500	.312	.600	4.5	CPGT 32.51	\$168
C08R SCLPR-3	▼	C08R SCLPL-3	○	14	.500	.312	.600	8		\$193
C10Q SCLPR-2	▼	C10Q SCLPL-2	○	8	.625	.406	.770	7		\$240
C10S SCLPR-2	▼	C10S SCLPL-2	○	8	.625	.406	.770	10	CPGT 21.51	\$282
C10Q SCLPR-3	▼	C10Q SCLPL-3	○	11	.625	.406	.770	7		\$240
C10S SCLPR-3	▼	C10S SCLPL-3	○	11	.625	.406	.770	10		\$282
C12Q SCLPR-3	▼	C12Q SCLPL-3	○	8	.750	.500	.930	7	CPGT 32.51	\$295
C12S SCLPR-3	▼	C12S SCLPL-3	○	8	.750	.500	.930	10		\$348
C16R SCLPR-3	▼	C16R SCLPL-3	○	6	1	.640	1.200	8		\$481
C16T SCLPR-3	▼	C16T SCLPL-3	○	6	1	.640	1.200	12		\$612

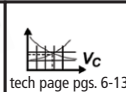
 ○ = EXPRESS DELIVERY
 ▼ = STOCK

Bars with no "K" angles have no flats.

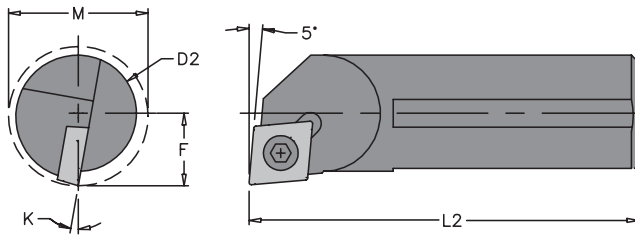

Right hand shown

CARBIDE SHANKS (Series ANSI) with Alloy Steel Head Coolant Thru

EVEREDE PART NUMBER				K	D2	F	M	L2	INSERTS	LIST PRICE
RIGHT HAND	DS	LEFT HAND	DS	ANGLE	SHANK DIA	DIM	MIN BORE	OAL		
E05M SCLPR-2	▼	E05M SCLPL-2	○	13	.312	.219	.415	6	CPGT 21.51	\$146
E06M SCLPR-2	▼	E06M SCLPL-2	○	12	.375	.250	.480	6		\$164
E08J SCLPR-2	▼	E08J SCLPL-2	○	12	.500	.312	.600	4.5		\$184
E08R SCLPR-2	▼	E08R SCLPL-2	○	12	.500	.312	.600	8		\$208
E08J SCLPR-3	▼	E08J SCLPL-3	○	14	.500	.312	.600	4.5	CPGT 32.51	\$184
E08R SCLPR-3	▼	E08R SCLPL-3	○	14	.500	.312	.600	8		\$208
E10Q SCLPR-2	▼	E10Q SCLPL-2	○	8	.625	.406	.770	7	CPGT 21.51	\$259
E10S SCLPR-2	▼	E10S SCLPL-2	○	8	.625	.406	.770	10		\$315
E10Q SCLPR-3	▼	E10Q SCLPL-3	○	11	.625	.406	.770	7	CPGT 32.51	\$259
E10S SCLPR-3	▼	E10S SCLPL-3	○	11	.625	.406	.770	10		\$315
E12Q SCLPR-3	▼	E12Q SCLPL-3	○	8	.750	.500	.930	7		\$325
E12S SCLPR-3	▼	E12S SCLPL-3	○	8	.750	.500	.930	10		\$376
E16R SCLPR-3	▼	E16R SCLPL-3	○	6	1	.640	1.200	8		\$481
E16T SCLPR-3	▼	E16T SCLPL-3	○	6	1	.640	1.200	12		\$612

- INSERTS
- CUTTING DATA
- KITS & SETS
- ANSI BORING BARS
- SERIES BORING BARS
- ROTATING TOOLS

○ = EXPRESS DELIVERY ▼ = STOCK	 <small>inserts p. 2</small>	 <small>screws p. 59</small>	 <small>wrenches p. 59</small>	 <small>tech page pgs. 6-13</small>	Bars with no "K" angles have no flats.
-----------------------------------	---------------------------------	---------------------------------	-----------------------------------	--	--

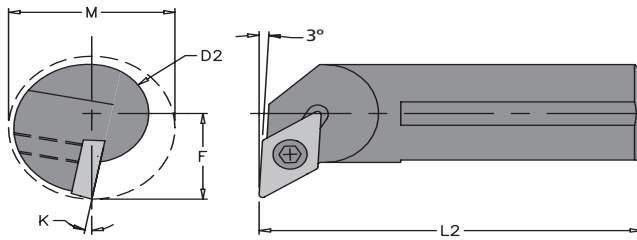

Right hand shown

ALLOY STEEL SHANKS (Series ANSI)

EVEREDE PART NUMBER				K	D2	F	M	L2		
RIGHT HAND	DS	LEFT HAND	DS	ANGLE	SHANK DIA	DIM	MIN BORE	OAL	INSERTS	LIST PRICE
S06M SDUCR-2	▼	S06M SDUCL-2	○	11	.375	.350	.600	6		\$62
S08R SDUCR-2	▼	S08R SDUCL-2	○	11	.500	.429	.730	8	DCGT 21.51	\$70
S10S SDUCR-2	▼	S10S SDUCL-2	○	10	.625	.459	.850	10		\$85
S12S SDUCR-3	▼	S12S SDUCL-3	○	10	.750	.554	.980	10	DCGT 32.51	\$96
S16T SDUCR-3	▼	S16T SDUCL-3	○	6	1	.750	1.500	12		\$129

ALLOY STEEL SHANKS (Series ANSI) with Coolant Thru

EVEREDE PART NUMBER				K	D2	F	M	L2		
RIGHT HAND	DS	LEFT HAND	DS	ANGLE	SHANK DIA	DIM	MIN BORE	OAL	INSERTS	LIST PRICE
A06M SDUCR-2	○	A06M SDUCL-2	○	11	.375	.350	.600	6		\$78
A08R SDUCR-2	○	A08R SDUCL-2	○	11	.500	.429	.730	8	DCGT 21.51	\$86
A10S SDUCR-2	○	A10S SDUCL-2	○	10	.625	.459	.850	10		\$101
A12S SDUCR-3	○	A12S SDUCL-3	○	10	.750	.554	.980	10	DCGT 32.51	\$112
A16T SDUCR-3	○	A16T SDUCL-3	○	6	1	.750	1.500	12		\$145

CARBIDE SHANKS (Series ANSI) with Alloy Steel Head

EVEREDE PART NUMBER				K	D2	F	M	L2		
RIGHT HAND	DS	LEFT HAND	DS	ANGLE	SHANK DIA	DIM	MIN BORE	OAL	INSERTS	LIST PRICE
C06M SDUCR-2	▼	C06M SDUCL-2	○	11	.375	.350	.600	6		\$165
C08R SDUCR-2	▼	C08R SDUCL-2	○	11	.500	.429	.730	8	DCGT 21.51	\$218
C10S SDUCR-2	▼	C10S SDUCL-2	○	10	.625	.459	.850	10		\$319
C12S SDUCR-3	▼	C12S SDUCL-3	○	10	.750	.554	.980	10	DCGT 32.51	\$381
C16T SDUCR-3	▼	C16T SDUCL-3	○	6	1	.750	1.500	12		\$650

CARBIDE SHANKS (Series ANSI) with Alloy Steel Head Coolant Thru

EVEREDE PART NUMBER				K	D2	F	M	L2		
RIGHT HAND	DS	LEFT HAND	DS	ANGLE	SHANK DIA	DIM	MIN BORE	OAL	INSERTS	LIST PRICE
E06M SDUCR-2	▼	E06M SDUCL-2	○	11	.375	.350	.600	6		\$182
E08R SDUCR-2	▼	E08R SDUCL-2	○	11	.500	.429	.730	8	DCGT 21.51	\$229
E10S SDUCR-2	▼	E10S SDUCL-2	○	10	.625	.459	.850	10		\$326
E12S SDUCR-3	▼	E12S SDUCL-3	○	10	.750	.554	.980	10	DCGT 32.51	\$395
E16T SDUCR-3	▼	E16T SDUCL-3	○	6	1	.750	1.500	12		\$643

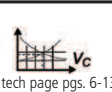
 ○ = EXPRESS DELIVERY
 ▼ = STOCK

Bars with no "K" angles have no flats.

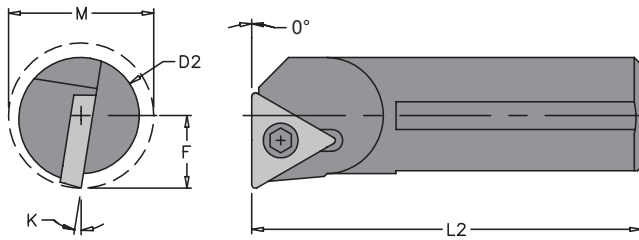

Right hand shown

ALLOY STEEL SHANKS (Series ANSI)

EVEREDE PART NUMBER				K	D2	F	M	L2	INSERTS	LIST PRICE
RIGHT HAND	DS	LEFT HAND	DS	ANGLE	SHANK DIA	DIM	MIN BORE	OAL		
S03G STFDR-1.3	▼	S03G STFDL-1.3	○	---	.187	.134	.270	3.5	TDHB 1.30.81	\$44
S04H STFDR-1.3	▼	S04H STFDL-1.3	○	---	.250	.156	.300	4		
S05H STFDR-1.3	▼	S05H STFDL-1.3	○	---	.312	.187	.360	4		
S06M STFDR-2	▼	S06M STFCL-2	○	12	.375	.250	.480	6	TCGT 21.51	\$49
S08R STFDR-2	▼	S08R STFCL-2	○	12	.500	.312	.600	8		\$55
S10S STFDR-2	▼	S10S STFCL-2	○	8	.625	.406	.770	10	TCGT 21.51	\$68
S10S STFDR-3	▼	S10S STFCL-3	○	11	.625	.406	.770	10		
S12S STFDR-3	▼	S12S STFCL-3	○	8	.750	.500	.930	10	TCGT 32.51	\$84
S16T STFDR-3	▼	S16T STFCL-3	○	6	1	.640	1.200	12		\$122

ALLOY STEEL SHANKS (Series ANSI) with Coolant Thru

EVEREDE PART NUMBER				K	D2	F	M	L2	INSERTS	LIST PRICE
RIGHT HAND	DS	LEFT HAND	DS	ANGLE	SHANK DIA	DIM	MIN BORE	OAL		
A05H STFDR-1.3	○	A05H STFDL-1.3	○	---	.312	.187	.360	4	TDHB 1.30.81	\$60
A06M STFDR-2	○	A06M STFCL-2	○	12	.375	.250	.480	6	TCGT 21.51	\$65
A08R STFDR-2	○	A08R STFCL-2	○	12	.500	.312	.600	8		\$71
A10S STFDR-2	○	A10S STFCL-2	○	8	.625	.406	.770	10	TCGT 21.51	\$87
A10S STFDR-3	○	A10S STFCL-3	○	11	.625	.406	.770	10		
A12S STFDR-3	○	A12S STFCL-3	○	8	.750	.500	.930	10	TCGT 32.51	\$102
A16T STFDR-3	○	A16T STFCL-3	○	6	1	.640	1.200	12		\$135

CARBIDE SHANKS (Series ANSI) with Alloy Steel Head

EVEREDE PART NUMBER				K	D2	F	M	L2	INSERTS	LIST PRICE
RIGHT HAND	DS	LEFT HAND	DS	ANGLE	SHANK DIA	DIM	MIN BORE	OAL		
C03H STFDR-1.3	▼	C03H STFDL-1.3	○	---	.187	.134	.270	4	TDHB 1.30.81	\$130
C04H STFDR-1.3	▼	C04H STFDL-1.3	○	---	.250	.156	.300	4		
C05H STFDR-1.3	▼	C05H STFDL-1.3	○	---	.312	.187	.360	4		
C06M STFDR-2	▼	C06M STFCL-2	○	12	.375	.250	.480	6	TCGT 21.51	\$149
C08J STFDR-2	▼	C08J STFCL-2	○	12	.500	.312	.600	4.5		\$168
C08R STFDR-2	▼	C08R STFCL-2	○	12	.500	.312	.600	8		\$193
C10Q STFDR-2	▼	C10Q STFCL-2	○	8	.625	.406	.770	7	TCGT 21.51	\$240
C10S STFDR-2	▼	C10S STFCL-2	○	8	.625	.406	.770	10		\$282
C10Q STFDR-3	▼	C10Q STFCL-3	○	11	.625	.406	.770	7	TCGT 32.51	\$240
C10S STFDR-3	▼	C10S STFCL-3	○	11	.625	.406	.770	10		\$282
C12Q STFDR-3	▼	C12Q STFCL-3	○	8	.750	.500	.930	7		\$295
C12S STFDR-3	▼	C12S STFCL-3	○	8	.750	.500	.930	10		\$348
C16R STFDR-3	▼	C16R STFCL-3	○	6	1	.640	1.200	8		\$481
C16T STFDR-3	▼	C16T STFCL-3	○	6	1	.640	1.200	12		\$612

○ = EXPRESS DELIVERY
▼ = STOCK

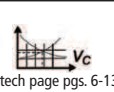

Bars with no "K" angles have no flats.

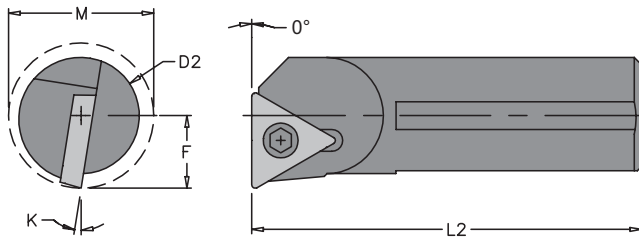

Right hand shown

CARBIDE SHANKS (Series ANSI) with Alloy Steel Head Coolant Thru

EVEREDE PART NUMBER				K	D2	F	M	L2		
RIGHT HAND	DS	LEFT HAND	DS	ANGLE	SHANK DIA	DIM	MIN BORE	OAL	INSERTS	LIST PRICE
E03H STFDR-1.3	▼	E03H STFDL-1.3	○	---	.187	.134	.270	4	TDHB 1.30.81	\$146
E04H STFDR-1.3	▼	E04H STFDL-1.3	○	---	.250	.156	.300	4		
E05H STFDR-1.3	▼	E05H STFDL-1.3	○	---	.312	.187	.360	4		
E06M STFDR-2	▼	E06M STFCL-2	○	12	.375	.250	.480	6	TCGT 21.51	\$164
E08J STFDR-2	▼	E08J STFCL-2	○	12	.500	.312	.600	4.5		\$184
E08R STFDR-2	▼	E08R STFCL-3	○	12	.500	.312	.600	8		\$208
E10Q STFDR-2	▼	E10Q STFCL-2	○	8	.625	.406	.770	7	TCGT 21.51	\$259
E10S STFDR-2	▼	E10S STFCL-2	○	8	.625	.406	.770	10		\$315
E10Q STFDR-3	▼	E10Q STFCL-3	○	11	.625	.406	.770	7	TCGT 32.51	\$259
E10S STFDR-3	▼	E10S STFCL-3	○	11	.625	.406	.770	10		\$315
E12Q STFDR-3	▼	E12Q STFCL-3	○	8	.750	.500	.930	7		\$325
E12S STFDR-3	▼	E12S STFCL-3	○	8	.750	.500	.930	10		\$376
E16R STFDR-3	▼	E16R STFCL-3	○	6	1	.640	1.200	8		\$481
E16T STFDR-3	▼	E16T STFCL-3	○	6	1	.640	1.200	12		\$612

INSERTS

CUTTING DATA

KITS & SETS

ANSI BORING BARS

SERIES BORING BARS

ROTATING TOOLS

○ = EXPRESS DELIVERY ▼ = STOCK	inserts p. 3	screws p. 59	wrenches p. 59	tech page pgs. 6-13	Bars with no "K" angles have no flats.
-----------------------------------	--------------	--------------	----------------	---------------------	--

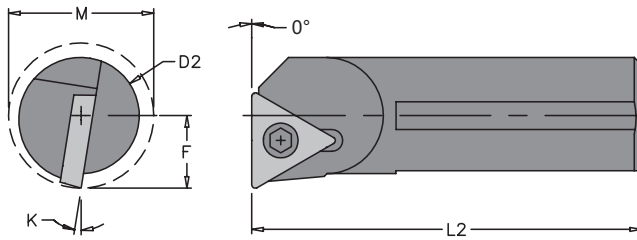

Right hand shown

ALLOY STEEL SHANKS (Series ANSI)

EVEREDE PART NUMBER				K	D2	F	M	L2	INSERTS	LIST PRICE
RIGHT HAND	DS	LEFT HAND	DS	ANGLE	SHANK DIA	DIM	MIN BORE	OAL		
S06M STFPR-2	▼	S06M STFPL-2	○	12	.375	.250	.480	6	TPGH 21.51	\$49
S08R STFPR-2	▼	S08R STFPL-2	○	12	.500	.312	.600	8		\$55
S10S STFPR-2	▼	S10S STFPL-2	○	8	.625	.406	.770	10	TPGH 21.51	\$68
S10S STFPR-3	▼	S10S STFPL-3	○	11	.625	.406	.770	10		\$84
S12S STFPR-3	▼	S12S STFPL-3	○	8	.750	.500	.930	10	TPGT 32.51	\$84
S16T STFPR-3	▼	S16T STFPL-3	○	6	1	.640	1.200	12		\$122

ALLOY STEEL SHANKS (Series ANSI) with Coolant Thru

EVEREDE PART NUMBER				K	D2	F	M	L2	INSERTS	LIST PRICE
RIGHT HAND	DS	LEFT HAND	DS	ANGLE	SHANK DIA	DIM	MIN BORE	OAL		
A06M STFPR-2	○	A06M STFPL-2	○	12	.375	.250	.480	6	TPGH 21.51	\$65
A08R STFPR-2	○	A08R STFPL-2	○	12	.500	.312	.600	8		\$71
A10S STFPR-2	○	A10S STFPL-2	○	8	.625	.406	.770	10	TPGH 21.51	\$87
A10S STFPR-3	○	A10S STFPL-3	○	11	.625	.406	.770	10		\$102
A12S STFPR-3	○	A12S STFPL-3	○	8	.750	.500	.930	10	TPGT 32.51	\$102
A16T STFPR-3	○	A16T STFPL-3	○	6	1	.640	1.200	12		\$135

CARBIDE SHANKS (Series ANSI) with Alloy Steel Head

EVEREDE PART NUMBER				K	D2	F	M	L2	INSERTS	LIST PRICE
RIGHT HAND	DS	LEFT HAND	DS	ANGLE	SHANK DIA	DIM	MIN BORE	OAL		
C06M STFPR-2	▼	C06M STFPL-2	○	12	.375	.250	.480	6	TPGH 21.51	\$149
C08J STFPR-2	▼	C08J STFPL-2	○	12	.500	.312	.600	4.5		\$168
C08R STFPR-2	▼	C08R STFPL-2	○	12	.500	.312	.600	8	TPGH 21.51	\$193
C10Q STFPR-2	▼	C10Q STFPL-2	○	8	.625	.406	.770	7		\$240
C10S STFPR-2	▼	C10S STFPL-2	○	8	.625	.406	.770	10	TPGH 21.51	\$282
C10Q STFPR-3	▼	C10Q STFPL-3	○	11	.625	.406	.770	7		\$240
C10S STFPR-3	▼	C10S STFPL-3	○	11	.625	.406	.770	10	TPGH 21.51	\$282
C12Q STFPR-3	▼	C12Q STFPL-3	○	8	.750	.500	.930	7		\$295
C12S STFPR-3	▼	C12S STFPL-3	○	8	.750	.500	.930	10	TPGT 32.51	\$348
C16R STFPR-3	▼	C16R STFPL-3	○	6	1	.640	1.200	8		\$481
C16T STFPR-3	▼	C16T STFPL-3	○	6	1	.640	1.200	12	TPGT 32.51	\$612

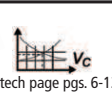
 ○ = EXPRESS DELIVERY
 ▼ = STOCK

Bars with no "K" angles have no flats.

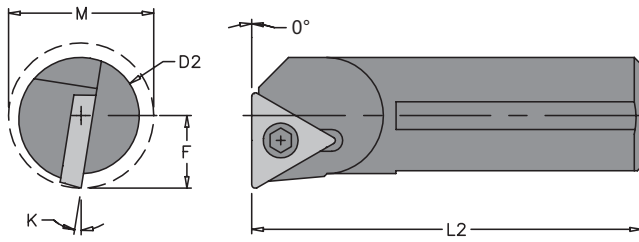

Right hand shown

CARBIDE SHANKS (Series ANSI) with Alloy Steel Head Coolant Thru

EVEREDE PART NUMBER				K	D2	F	M	L2	INSERTS	LIST PRICE
RIGHT HAND	DS	LEFT HAND	DS	ANGLE	SHANK DIA	DIM	MIN BORE	OAL		
E06M STFPR-2	▼	E06M STFPL-2	○	12	.375	.250	.480	6	TPGH 21.51	\$164
E08J STFPR-2	▼	E08J STFPL-2	○	12	.500	.312	.600	4.5		\$184
E08R STFPR-2	▼	E08R STFPL-2	○	12	.500	.312	.600	8	TPGH 21.51	\$208
E10Q STFPR-2	▼	E10Q STFPL-2	○	8	.625	.406	.770	7		\$259
E10S STFPR-2	▼	E10S STFPL-2	○	8	.625	.406	.770	10	TPGH 21.51	\$315
E10Q STFPR-3	▼	E10Q STFPL-3	○	11	.625	.406	.770	7		\$259
E10S STFPR-3	▼	E10S STFPL-3	○	11	.625	.406	.770	10	TPGT 32.51	\$315
E12Q STFPR-3	▼	E12Q STFPL-3	○	8	.750	.500	.930	7		\$325
E12S STFPR-3	▼	E12S STFPL-3	○	8	.750	.500	.930	10	TPGT 32.51	\$376
E16R STFPR-3	▼	E16R STFPL-3	○	6	1	.640	1.200	8		\$481
E16T STFPR-3	▼	E16T STFPL-3	○	6	1	.640	1.200	12	TPGT 32.51	\$612

INSERTS

CUTTING DATA

KITS & SETS

ANSI BORING BARS

SERIES BORING BARS

ROTATING TOOLS

○ = EXPRESS DELIVERY ▼ = STOCK	inserts p. 3-4	screws p. 59	wrenches p. 59	tech page pgs. 6-13	Bars with no "K" angles have no flats.
-----------------------------------	----------------	--------------	----------------	---------------------	--

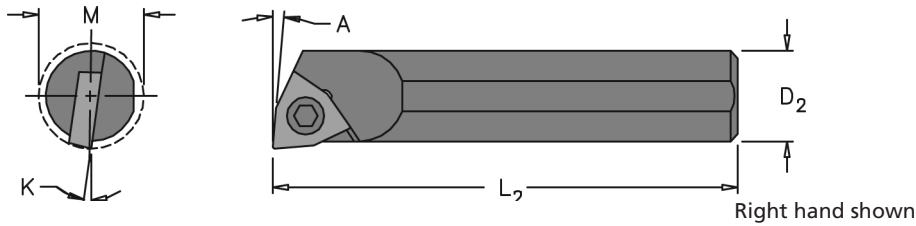
ALLOY STEEL SHANKS (Series ANSI)





EVEREDE PART NUMBER				K	D2	F	M	L2	INSERTS	LIST PRICE
RIGHT HAND	DS	LEFT HAND	DS	ANGLE	SHANK DIA	DIM	MIN BORE	OAL		
S03E SWLCR-1.2	▼	S03E SWLCL-1.2	○	20	.187	.115	.230	2.5	WCGT 1.211	\$44
S04H SWLCR-1.2	▼	S04H SWLCL-1.2	○	17	.250	.145	.290	4		
S05K SWLCR-1.5	▼	S05K SWLCL-1.5	○	17	.312	.180	.360	5	WCGT 1.51.51	\$49
S06M SWLCR-2	▼	S06M SWLCL-2	○	12	.375	.250	.480	6		
S08R SWLCR-2	▼	S08R SWLCL-2	○	12	.500	.312	.600	8	WCGT 21.51	\$55
S08R SWLCR-3	▼	S08R SWLCL-3	○	14	.500	.312	.600	8		
S10S SWLCR-2	▼	S10S SWLCL-2	○	11	.625	.406	.770	10	WCGT 21.51	\$68
S10S SWLCR-3	▼	S10S SWLCL-3	○	11	.625	.406	.770	10		
S12S SWLCR-3	▼	S12S SWLCL-3	○	8	.750	.500	.930	10	WCGT 32.51	\$84
S16T SWLCR-3	▼	S16T SWLCL-3	○	6	1	.640	1.200	12		

ALLOY STEEL SHANKS (Series ANSI) with Coolant Thru

EVEREDE PART NUMBER				K	D2	F	M	L2	INSERTS	LIST PRICE
RIGHT HAND	DS	LEFT HAND	DS	ANGLE	SHANK DIA	DIM	MIN BORE	OAL		
A05K SWLCR-1.5	○	A05K SWLCL-1.5	○	17	.312	.180	.360	5	WCGT 1.51.51	\$60
A06M SWLCR-2	○	A06M SWLCL-2	○	12	.375	.250	.480	6		
A08R SWLCR-2	○	A08R SWLCL-2	○	12	.500	.312	.600	8	WCGT 21.51	\$71
A08R SWLCR-3	○	A08R SWLCL-3	○	14	.500	.312	.600	8		
A10S SWLCR-2	○	A10S SWLCL-2	○	11	.625	.406	.770	10	WCGT 21.51	\$87
A10S SWLCR-3	○	A10S SWLCL-3	○	11	.625	.406	.770	10		
A12S SWLCR-3	○	A12S SWLCL-3	○	8	.750	.500	.930	10	WCGT 32.51	\$102
A16T SWLCR-3	○	A16T SWLCL-3	○	6	1	.640	1.200	12		

CARBIDE SHANKS (Series ANSI) with Alloy Steel Head

EVEREDE PART NUMBER				K	D2	F	M	L2	INSERTS	LIST PRICE
RIGHT HAND	DS	LEFT HAND	DS	ANGLE	SHANK DIA	DIM	MIN BORE	OAL		
C03H SWLCR-1.2	▼	C03H SWLCL-1.2	○	20	.187	.115	.230	4	WCGT 1.211	\$130
C04H SWLCR-1.2	▼	C04H SWLCL-1.2	○	17	.250	.145	.290	4		
C05M SWLCR-1.5	▼	C05M SWLCL-1.5	○	17	.312	.180	.360	6	WCGT 1.51.51	\$149
C06M SWLCR-2	▼	C06M SWLCL-2	○	12	.375	.250	.480	6		
C08J SWLCR-2	▼	C08J SWLCL-2	○	12	.500	.312	.600	4.5	WCGT 21.51	\$168
C08R SWLCR-2	▼	C08R SWLCL-2	○	12	.500	.312	.600	8		
C08J SWLCR-3	▼	C08J SWLCL-3	○	12	.500	.312	.600	4.5	WCGT 32.51	\$168
C08R SWLCR-3	▼	C08R SWLCL-3	○	12	.500	.312	.600	8		
C10Q SWLCR-2	▼	C10Q SWLCL-2	○	11	.625	.406	.770	7	WCGT 21.51	\$240
C10S SWLCR-2	▼	C10S SWLCL-2	○	11	.625	.406	.770	10		
C10Q SWLCR-3	▼	C10Q SWLCL-3	○	11	.625	.406	.770	7	WCGT 32.51	\$240
C10S SWLCR-3	▼	C10S SWLCL-3	○	11	.625	.406	.770	10		
C12Q SWLCR-3	▼	C12Q SWLCL-3	○	8	.750	.500	.930	7	WCGT 32.51	\$295
C12S SWLCR-3	▼	C12S SWLCL-3	○	8	.750	.500	.930	10		
C16R SWLCR-3	▼	C16R SWLCL-3	○	6	1	.640	1.200	8	WCGT 32.51	\$481
C16T SWLCR-3	▼	C16T SWLCL-3	○	6	1	.640	1.200	12		

○ = EXPRESS DELIVERY ▼ = STOCK	 inserts p. 5	 screws p. 59	 wrenches p. 59	 tech page pgs. 6-13	Bars with no "K" angles have no flats.
-----------------------------------	--	--	--	---	--

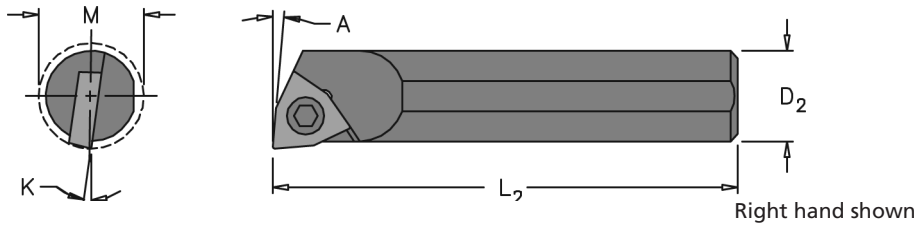

CARBIDE SHANKS (Series ANSI) with Alloy Steel Head Coolant Thru

EVEREDE PART NUMBER				K	D2	F	M	L2	INSERTS	LIST PRICE
RIGHT HAND	DS	LEFT HAND	DS	ANGLE	SHANK DIA	DIM	MIN BORE	OAL		
E03H SWLCR-1.2	▼	E03H SWLCL-1.2	○	20	.187	.115	.230	4	WCGT 1.211	\$146
E04H SWLCR-1.2	▼	E04H SWLCL-1.2	○	17	.250	.145	.290	4		
E05M SWLCR-1.5	▼	E05M SWLCL-1.5	○	17	.312	.180	.360	6	WCGT-1.51.51	
E06M SWLCR-2	▼	E06M SWLCL-2	○	12	.375	.250	.480	6	WCGT 21.51	\$164
E08J SWLCR-2	▼	E08J SWLCL-2	○	12	.500	.312	.600	4.5		\$184
E08R SWLCR-2	▼	E08R SWLCL-2	○	12	.500	.312	.600	8	WCGT 32.51	\$208
E08J SWLCR-3	▼	E08J SWLCL-3	○	12	.500	.312	.600	4.5		\$184
E08R SWLCR-3	▼	E08R SWLCL-3	○	12	.500	.312	.600	8		\$208
E10Q SWLCR-2	▼	E10Q SWLCL-2	○	11	.625	.406	.770	7	WCGT 21.51	\$259
E10S SWLCR-2	▼	E10S SWLCL-2	○	11	.625	.406	.770	10	WCGT 32.51	\$315
E10Q SWLCR-3	▼	E10Q SWLCL-3	○	11	.625	.406	.770	7		\$259
E10S SWLCR-3	▼	E10S SWLCL-3	○	11	.625	.406	.770	10		\$315
E12Q SWLCR-3	▼	E12Q SWLCL-3	○	8	.750	.500	.930	7	WCGT 32.51	\$325
E12S SWLCR-3	▼	E12S SWLCL-3	○	8	.750	.500	.930	10		\$376
E16R SWLCR-3	▼	E16R SWLCL-3	○	6	1	.640	1.200	8		\$481
E16T SWLCR-3	▼	E16T SWLCL-3	○	6	1	.640	1.200	12		\$612

INSERTS

CUTTING DATA

KITS & SETS

ANSI BORING BARS

SERIES BORING BARS

ROTATING TOOLS

○ = EXPRESS DELIVERY ▼ = STOCK	inserts p. 5	screws p. 59	wrenches p. 59	tech page pgs. 6-13	Bars with no "K" angles have no flats.
-----------------------------------	--------------	--------------	----------------	---------------------	--



1. S = Steel
C = Carbide
H = Heavy Metal
2. A Series uses CD.. type inserts
B Series uses TD.. type inserts
C Series uses TP..2 type inserts
D Series uses TP..3 type inserts
E Series uses WCGT0
F Series uses WCGT1
G Series uses WCGT2
H Series uses WCGT3
3. Add L to part number for left hand bar. Express delivery.
4. Add CH to part number for coolant hole. Coolant hole is available in all sizes of carbide bars and in steel bars beginning at 3/8". Heavy metal bars are available with coolant hole as *specials only*. Oversize shank carbide bars are available with coolant hole as *specials only*. Steel coolant and left hand bars are express delivery.
5. Straight shank boring bars in **Series A through D** may be used in collet holders and do not have flats. Flats may be ordered using the following identification*:

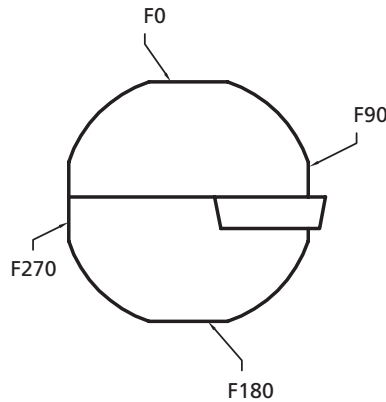

Front view of bar.

* Multiple flats may be ordered by combining identifications (e.g., F0F180). Flats are 2 day delivery.

NOTE: Use LEFT hand ground chipbreaker insert with RIGHT hand boring bars.
Use RIGHT hand ground chipbreaker insert with LEFT hand boring bars.

NOTE: METRIC SHANK BORING BARS ARE AVAILABLE, UPON REQUEST.

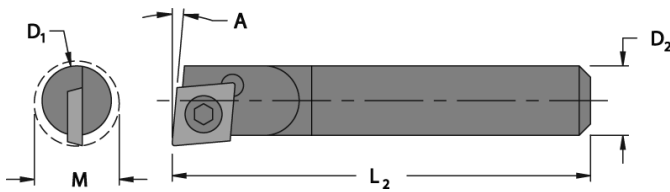

All bars have 5° positive axial rake.
5° angle bars for facing and through hole boring.
0° angle for through hole boring and boring to shoulder.

ALLOY STEEL SHANKS (Series A)

EVEREDE PART NUMBER	A	D1	D2	M	L2	INSERTS
	ANGLE	BAR DIA	SHANK DIA	MIN BORE	OAL	
SA1000*	7	.165	.187	.180	2.500	CDCD or CDCC or CDCH See Inserts page 2
SA1005	5	.180	.187	.208	2.500	
SA1010	5	.187	.187	.230	2.500	
SA1015	0	.187	.187	.244	2.500	
SA1100	5	.250	.250	.290	3.000	
SA1105	0	.250	.250	.300	3.000	

* Bar Dia length is .500

CARBIDE SHANKS (Series A) with Alloy Steel Head

EVEREDE PART NUMBER	A	D1	D2	M	L2	INSERTS
	ANGLE	BAR DIA	SHANK DIA	MIN BORE	OAL	
CA1200	7	.165	.156	.180	4.000	CDCD or CDCC or CDCH See Inserts page 2
CA1205	5	.180	.187	.208	4.000	
CA1210	5	.180	.187	.208	6.000	
CA1215	5	.187	.187	.230	4.000	
CA1220	0	.187	.187	.244	4.000	
CA1225	5	.187	.187	.230	6.000	
CA1230	0	.187	.187	.244	6.000	
CA1300	5	.250	.250	.290	4.000	
CA1305	0	.250	.250	.300	4.000	
CA1310	5	.250	.250	.290	6.000	
CA1315	0	.250	.250	.300	6.000	
CA1330	5	.312	.312	.356	6.000	
CA1335	0	.312	.312	.356	6.000	

HEAVY METAL SHANKS (Series A)

EVEREDE PART NUMBER	A	D1	D2	M	L2	INSERTS
	ANGLE	BAR DIA	SHANK DIA	MIN BORE	OAL	
HA1205	5	.180	.187	.208	4.000	CDCD or CDCC or CDCH See Inserts page 2
HA1215	5	.187	.187	.230	4.000	
HA1220	0	.187	.187	.244	4.000	
HA1300	5	.250	.250	.290	4.000	
HA1305	0	.250	.250	.300	4.000	
HA1310	5	.250	.250	.290	6.000	
HA1315	0	.250	.250	.300	6.000	

- Most bars are available left handed. Please add letter "L" after part number.
- Most bars are available coolant thru. Please add letter "CH" after part number.

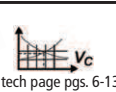
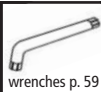

- All bars can be ordered with flats.
- See "BORING BAR ORDERING INFORMATION" pg. 27 for details.

INSERTS

CUTTING DATA

KITS & SETS

ANSI BORING BARS

SERIES BORING BARS

ROTATING TOOLS

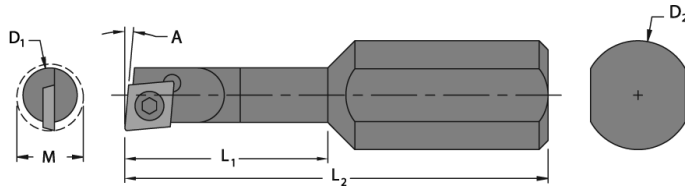

All bars have 5° positive axial rake.
 5° angle bars for facing and through hole boring.
 0° angle for through hole boring and boring to shoulder.

ALLOY STEEL SHANKS (Series A)

EVEREDE PART NUMBER	A	D1	D2	M	L1	L2	INSERTS
	ANGLE	BAR DIA	SHANK DIA	MIN BORE	BAR LENGTH	OAL	
SA1400	5	.180	.375	.208	0.500	2.250	CDCD or CDCC or CDCH
SA1405	5	.180	.375	.208	1.000	2.250	
SA1410	5	.203	.375	.230	0.500	2.250	
SA1415	0	.203	.375	.244	0.500	2.250	
SA1420	5	.203	.375	.230	1.000	2.250	
SA1425	0	.203	.375	.244	1.000	2.250	
SA1430	5	.250	.375	.290	0.750	2.500	
SA1435	0	.250	.375	.300	0.750	2.500	
SA1440	5	.250	.375	.290	1.250	2.500	
SA1445	0	.250	.375	.300	1.250	2.500	
SA1600	5	.180	.500	.208	0.500	2.500	
SA1605	5	.180	.500	.208	1.000	2.500	
SA1610	5	.203	.500	.230	0.500	2.500	
SA1615	0	.203	.500	.244	0.500	2.500	
SA1620	5	.203	.500	.230	1.000	2.500	
SA1625	0	.203	.500	.244	1.000	2.500	
SA1630	5	.250	.500	.290	0.750	2.750	
SA1635	0	.250	.500	.300	0.750	2.750	
SA1640	5	.250	.500	.290	1.250	2.750	
SA1645	0	.250	.500	.300	1.250	2.750	

See Inserts page 2

CARBIDE BARS (Series A) with Alloy Steel Head and Shank

EVEREDE PART NUMBER	A	D1	D2	M	L1	L2	INSERTS
	ANGLE	BAR DIA	SHANK DIA	MIN BORE	BAR LENGTH	OAL	
CA1700	5	.180	.500	.208	0.875	2.375	CDCD or CDCC or CDCH
CA1705	5	.180	.500	.208	1.875	3.375	
CA1710	5	.203	.500	.230	1.000	2.500	
CA1715	0	.203	.500	.244	1.000	2.500	
CA1720	5	.203	.500	.230	2.000	3.500	
CA1725	0	.203	.500	.244	2.000	3.500	
CA1730	5	.250	.500	.290	1.250	2.750	
CA1735	0	.250	.500	.300	1.250	2.750	
CA1740	5	.250	.500	.290	2.500	4.000	
CA1745	0	.250	.500	.300	2.500	4.000	

See Inserts page 2

- Most bars are available left handed. Please add letter "L" after part number.
- Most bars are available coolant thru. Please add letter "CH" after part number.

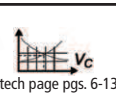

- Oversize shank carbide bars are NOT available with coolant hole.
- See "BORING BAR ORDERING INFORMATION" pg. 27 for details.

INSERTS
 CUTTING DATA
 KITS & SETS
 ANSI BORING BARS
 SERIES BORING BARS
 ROTATING TOOLS

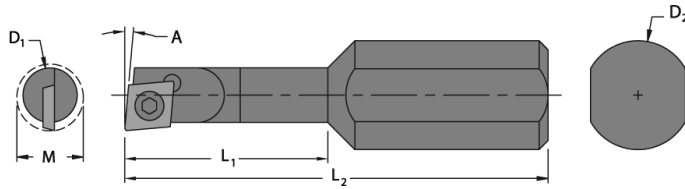

All bars have 5° positive axial rake.
 5° angle bars for facing and through hole boring.
 0° angle for through hole boring and boring to shoulder.

CARBIDE BARS (Series A) with Alloy Steel Head and Shank

EVEREDE PART NUMBER	A	D1	D2	M	L1	L2	INSERTS
	ANGLE	BAR DIA	SHANK DIA	MIN BORE	BAR LENGTH	OAL	
CA1500	5	.180	.625	.208	0.875	3.875	CDGD or CDCC or CDCH
CA1505	5	.180	.625	.208	1.875	4.875	
CA1510	5	.203	.625	.230	1.000	4.000	
CA1515	0	.203	.625	.244	1.000	4.000	
CA1520	5	.203	.625	.230	2.000	5.000	
CA1525	0	.203	.625	.244	2.000	5.000	
CA1530	5	.250	.625	.290	1.250	4.000	
CA1535	0	.250	.625	.300	1.250	4.000	
CA1540	5	.250	.625	.290	2.500	5.250	
CA1545	0	.250	.625	.300	2.500	5.250	

See Inserts page 2

INSERTS

CUTTING DATA

KITS & SETS

ANSI BORING BARS

SERIES BORING BARS

ROTATING TOOLS

- Most bars are available left handed. Please add letter "L" after part number.
- Most bars are available coolant thru. Please add letter "CH" after part number.

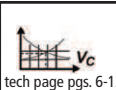

- Oversize shank carbide bars are NOT available with coolant hole.
- See "BORING BAR ORDERING INFORMATION" pg. 27 for details.

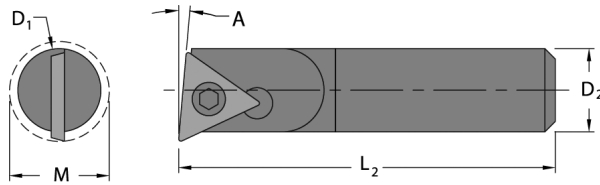

All bars have 5° positive axial rake.
 5° angle bars for facing and through hole boring.
 0° angle for through hole boring and boring to shoulder.

ALLOY STEEL SHANKS (Series B)

EVEREDE PART NUMBER	A	D1	D2	M	L2	INSERTS
	ANGLE	BAR DIA	SHANK DIA	MIN BORE	OAL	
SB1800	5	.187	.187	.270	3.500	TDAB or TDAC See Inserts page 3
SB1805	0	.187	.187	.270	3.500	
SB2000	5	.250	.250	.300	4.000	
SB2005	0	.250	.250	.300	4.000	
SB2100	5	.312	.312	.360	4.000	
SB2105	0	.312	.312	.360	4.000	

CARBIDE SHANKS (Series B) with Alloy Steel Head

EVEREDE PART NUMBER	A	D1	D2	M	L2	INSERTS
	ANGLE	BAR DIA	SHANK DIA	MIN BORE	OAL	
CB1900	5	.187	.187	.270	4.000	TDAB or TDAC See Inserts page 3
CB1905	0	.187	.187	.270	4.000	
CB1910	5	.187	.187	.270	6.000	
CB1915	0	.187	.187	.270	6.000	
CB2200	5	.250	.250	.300	4.000	
CB2205	0	.250	.250	.300	4.000	
CB2210	5	.250	.250	.300	6.000	
CB2215	0	.250	.250	.300	6.000	
CB2300	5	.312	.312	.360	4.000	
CB2305	0	.312	.312	.360	4.000	
CB2310	5	.312	.312	.360	6.000	
CB2315	0	.312	.312	.360	6.000	

- Most bars are available left handed. Please add letter "L" after part number.
- Most bars are available coolant thru. Please add letter "CH" after part number.

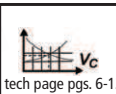

- All bars can be ordered with flats.
- See "BORING BAR ORDERING INFORMATION" pg. 27 for details.

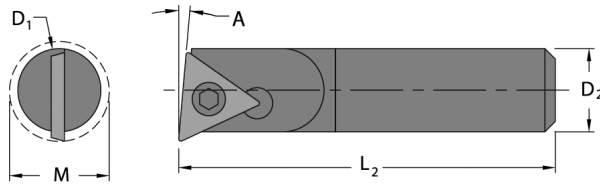

All bars have 5° positive axial rake.
5° angle bars for facing and through hole boring.
0° angle for through hole boring and boring to shoulder.

HEAVY METAL SHANKS (Series B)

EVEREDE PART NUMBER	A	D1	D2	M	L2	INSERTS
	ANGLE	BAR DIA	SHANK DIA	MIN BORE	OAL	
HB1900	5	.187	.187	.270	4.000	TDAB or TDAC
HB1905	0	.187	.187	.270	4.000	
HB1910	5	.187	.187	.270	6.000	
HB1915	0	.187	.187	.270	6.000	
HB2200	5	.250	.250	.300	4.000	
HB2205	0	.250	.250	.300	4.000	
HB2210	5	.250	.250	.300	6.000	
HB2215	0	.250	.250	.300	6.000	
HB2300	5	.312	.312	.360	4.000	
HB2305	0	.312	.312	.360	4.000	
HB2310	5	.312	.312	.360	6.000	
HB2315	0	.312	.312	.360	6.000	

See Inserts page 3

INSERTS

CUTTING DATA

KITS & SETS

ANSI BORING BARS

SERIES BORING BARS

ROTATING TOOLS

- Most bars are available left handed. Please add letter "L" after part number.
- Most bars are available coolant thru. Please add letter "CH" after part number.

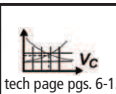

- All bars can be ordered with flats.
- See "BORING BAR ORDERING INFORMATION" pg. 27 for details.

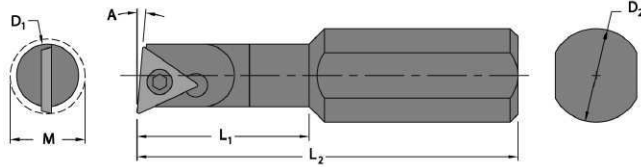

All bars have 5° positive axial rake.
 5° angle bars for facing and through hole boring.
 0° angle for through hole boring and boring to shoulder.

ALLOY STEEL SHANKS (Series B)

EVEREDE PART NUMBER	A	D1	D2	M	L1	L2	INSERTS
	ANGLE	BAR DIA	SHANK DIA	MIN BORE	BAR LENGTH	OAL	
SB2400	5	.203	.500	.270	.500	2.500	TDAB or TDAC
SB2405	0	.203	.500	.270	.500	2.500	
SB2410	5	.203	.500	.270	1.000	2.500	
SB2415	0	.203	.500	.270	1.000	2.500	
SB2420	5	.250	.500	.300	.750	2.750	
SB2425	0	.250	.500	.300	.750	2.750	
SB2430	5	.250	.500	.300	1.250	2.750	
SB2435	0	.250	.500	.300	1.250	2.750	
SB2440	5	.312	.500	.360	1.000	3.000	
SB2445	0	.312	.500	.360	1.000	3.000	
SB2450	5	.312	.500	.360	1.500	3.000	
SB2455	0	.312	.500	.360	1.500	3.000	
SB2500	5	.203	.625	.270	.500	4.000	
SB2505	0	.203	.625	.270	.500	4.000	
SB2510	5	.203	.625	.270	1.000	4.000	
SB2515	0	.203	.625	.270	1.000	4.000	
SB2520	5	.250	.625	.300	.750	4.000	
SB2525	0	.250	.625	.300	.750	4.000	
SB2530	5	.250	.625	.300	1.250	4.000	
SB2535	0	.250	.625	.300	1.250	4.000	
SB2540	5	.312	.625	.360	1.000	4.000	
SB2545	0	.312	.625	.360	1.000	4.000	
SB2550	5	.312	.625	.360	1.500	4.000	
SB2555	0	.312	.625	.360	1.500	4.000	

See Inserts page 3

- INSERTS
- CUTTING DATA
- KITS & SETS
- ANSI BORING BARS
- SERIES BORING BARS
- ROTATING TOOLS

- Most bars are available left handed. Please add letter "L" after part number.
- Most bars are available coolant thru. Please add letter "CH" after part number.

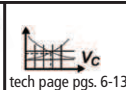

- See "BORING BAR ORDERING INFORMATION" pg. 27 for details.

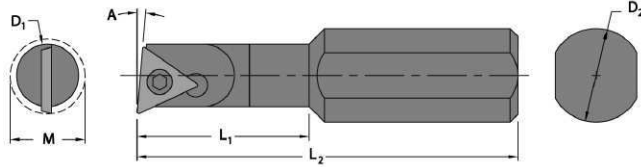

All bars have 5° positive axial rake.
5° angle bars for facing and through hole boring.
0° angle for through hole boring and boring to shoulder.

CARBIDE BARS (Series B) with Alloy Steel Head and Shank

EVEREDE PART NUMBER	A	D1	D2	M	L1	L2	INSERTS
	ANGLE	BAR DIA	SHANK DIA	MIN BORE	BAR LENGTH	OAL	
CB2460	5	.203	.500	.270	1.000	2.500	TDAB or TDAC
CB2461	0	.203	.500	.270	1.000	2.500	
CB2462	5	.203	.500	.270	2.000	3.500	
CB2463	0	.203	.500	.270	2.000	3.500	
CB2464	5	.250	.500	.300	1.250	2.750	
CB2465	0	.250	.500	.300	1.250	2.750	
CB2466	5	.250	.500	.300	2.500	4.000	
CB2467	0	.250	.500	.300	2.500	4.000	
CB2468	5	.312	.500	.360	1.500	3.000	
CB2469	0	.312	.500	.360	1.500	3.000	
CB2470	5	.312	.500	.360	3.125	4.625	
CB2471	0	.312	.500	.360	3.125	4.625	
CB2600	5	.203	.625	.270	1.000	4.000	
CB2605	0	.203	.625	.270	1.000	4.000	
CB2610	5	.203	.625	.270	2.000	5.000	
CB2615	0	.203	.625	.270	2.000	5.000	
CB2620	5	.250	.625	.300	1.250	4.000	
CB2625	0	.250	.625	.300	1.250	4.000	
CB2630	5	.250	.625	.300	2.500	5.250	
CB2635	0	.250	.625	.300	2.500	5.250	
CB2640	5	.312	.625	.360	1.500	4.000	
CB2645	0	.312	.625	.360	1.500	4.000	
CB2650	5	.312	.625	.360	3.125	5.625	
CB2655	0	.312	.625	.360	3.125	5.625	

See Inserts page 3

INSERTS

CUTTING DATA

KITS & SETS

ANSI BORING BARS

SERIES BORING BARS

ROTATING TOOLS

- Most bars are available left handed. Please add letter "L" after part number.
- Most bars are available coolant thru. Please add letter "CH" after part number.

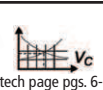

- Oversize shank carbide bars are NOT available with coolant hole.
- See "BORING BAR ORDERING INFORMATION" pg. 27 for details.

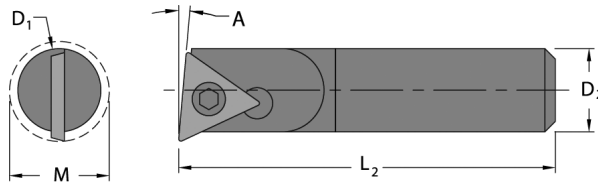

All bars have 5° positive axial rake.
 5° angle bars for facing and through hole boring.
 0° angle for through hole boring and boring to shoulder.

ALLOY STEEL SHANKS (Series C)

EVEREDE PART NUMBER	A	D1	D2	M	L2	INSERTS
	ANGLE	BAR DIA	SHANK DIA	MIN BORE	OAL	
SC2700	5°	.375	.375	.438	5.000	TPGB-2 or TPGH-2 or TPGC-2 <small>See Inserts page 3</small>
SC2705	0°	.375	.375	.438	5.000	
SC2800	5°	.500	.500	.563	6.000	
SC2805	0°	.500	.500	.563	6.000	

CARBIDE SHANKS (Series C) with Alloy Steel Head

EVEREDE PART NUMBER	A	D1	D2	M	L2	INSERTS
	ANGLE	BAR DIA	SHANK DIA	MIN BORE	OAL	
CC2900	5°	.375	.375	.438	6.000	TPGB-2 or TPGH-2 or TPGC-2 <small>See Inserts page 3</small>
CC2905	0°	.375	.375	.438	6.000	
CC2910	5°	.375	.375	.438	10.000	
CC2915	0°	.375	.375	.438	10.000	
CC3000	5°	.500	.500	.563	8.000	
CC3005	0°	.500	.500	.563	8.000	
CC3010	5°	.500	.500	.563	10.000	
CC3015	0°	.500	.500	.563	10.000	

HEAVY METAL SHANKS (Series C)

EVEREDE PART NUMBER	A	D1	D2	M	L2	INSERTS
	ANGLE	BAR DIA	SHANK DIA	MIN BORE	OAL	
HC2900	5°	.375	.375	.438	6.000	TPGB-2 or TPGH-2 or TPGC-2 <small>See Inserts page 3</small>
HC2905	0°	.375	.375	.438	6.000	
HC2910	5°	.375	.375	.438	10.000	
HC2915	0°	.375	.375	.438	10.000	
HC3000	5°	.500	.500	.563	6.000	
HC3005	0°	.500	.500	.563	6.000	
HC3010	5°	.500	.500	.563	10.000	
HC3015	0°	.500	.500	.563	10.000	

- Most bars are available left handed. Please add letter "L" after part number.
- Most bars are available coolant thru. Please add letter "CH" after part number.

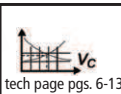

- All bars can be ordered with flats.
- See "BORING BAR ORDERING INFORMATION" pg. 27 for details.

 INSERTS
 CUTTING DATA
 KITS & SETS
 ANSI BORING BARS
 SERIES BORING BARS
 ROTATING TOOLS

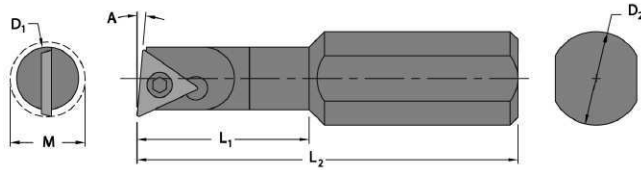

All bars have 5° positive axial rake.
 5° angle bars for facing and through hole boring.
 0° angle for through hole boring and boring to shoulder.

ALLOY STEEL SHANKS (Series C)

EVEREDE PART NUMBER	A	D1	D2	M	L1	L2	INSERTS
	ANGLE	BAR DIA	SHANK DIA	MIN BORE	BAR LENGTH	OAL	
SC3020	5°	.375	.500	.438	1.125	4.000	TPGB-2 or TPGH-2 or TPGC-2
SC3025	0°	.375	.500	.438	1.125	4.000	
SC3030	5°	.375	.500	.438	1.875	4.000	
SC3035	0°	.375	.500	.438	1.875	4.000	
SC3040	5°	.375	.625	.438	1.125	3.750	
SC3045	0°	.375	.625	.438	1.125	3.750	
SC3050	5°	.375	.625	.438	1.875	3.750	
SC3055	0°	.375	.625	.438	1.875	3.750	
SC3060	5°	.500	.625	.563	1.500	4.250	
SC3065	0°	.500	.625	.563	1.500	4.250	
SC3070	5°	.500	.625	.563	2.500	4.250	
SC3075	0°	.500	.625	.563	2.500	4.250	
SC3080	5°	.375	.750	.438	1.500	4.000	
SC3085	0°	.375	.750	.438	1.500	4.000	
SC3090	5°	.625	.750	.688	2.500	4.500	
SC3095	0°	.625	.750	.688	2.500	4.500	

See Inserts page 3

INSERTS

CUTTING DATA

KITS & SETS

 ANSI
BORING BARS

 SERIES
BORING BARS

ROTATING TOOLS

- Most bars are available left handed. Please add letter "L" after part number.
- Most bars are available coolant thru. Please add letter "CH" after part number.

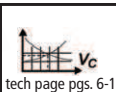

- See "BORING BAR ORDERING INFORMATION" pg. 27 for details.

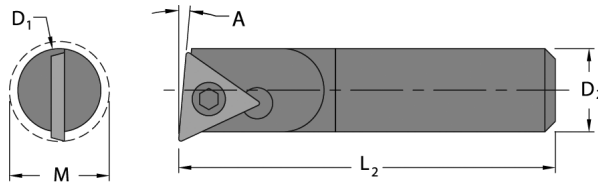





All bars have 5° positive axial rake.
 5° angle bars for facing and through hole boring.
 0° angle for through hole boring and boring to shoulder.

ALLOY STEEL SHANKS (Series D)

EVEREDE PART NUMBER	A	D1	D2	M	L2	INSERTS
	ANGLE	BAR DIA	SHANK DIA	MIN BORE	OAL	
SD3100	5	.500	.500	.625	2.500	TPGB-3 or TPGH-3 or TPGC-3
SD3105	0	.500	.500	.625	2.500	
SD3400	5	.500	.500	.625	6.000	
SD3405	0	.500	.500	.625	6.000	
SD3110	5	.625	.625	.719	4.000	
SD3115	0	.625	.625	.719	4.000	
SD3500	5	.625	.625	.719	7.000	
SD3505	0	.625	.625	.719	7.000	
SD3200	5	.750	.750	.844	4.000	
SD3205	0	.750	.750	.844	4.000	
SD3600	5	.750	.750	.844	8.000	
SD3605	0	.750	.750	.844	8.000	
SD3300	5	1.000	1.000	1.094	5.000	
SD3305	0	1.000	1.000	1.094	5.000	
SD3700	5	1.000	1.000	1.094	10.000	
SD3705	0	1.000	1.000	1.094	10.000	
SD3800	5	1.250	1.250	1.344	12.000	
SD3805	0	1.250	1.250	1.344	12.000	

See Inserts page 4

- INSERTS
- CUTTING DATA
- KITS & SETS
- ANSI BORING BARS
- SERIES BORING BARS
- ROTATING TOOLS

<ul style="list-style-type: none"> Most bars are available left handed. Please add letter "L" after part number. Most bars are available coolant thru. Please add letter "CH" after part number. 	 <small>inserts p. 4</small>	 <small>screws p. 59</small>	 <small>wrenches p. 59</small>	 <small>tech page pgs. 6-13</small>	<ul style="list-style-type: none"> All bars can be ordered with flats. See "BORING BAR ORDERING INFORMATION" pg. 27 for details.
--	--	--	--	--	--

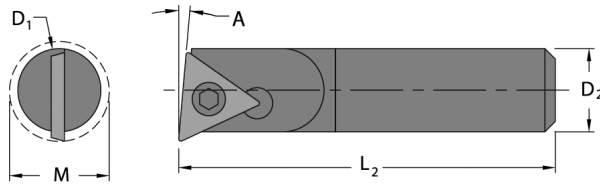

All bars have 5° positive axial rake.
5° angle bars for facing and through hole boring.
0° angle for through hole boring and boring to shoulder.

CARBIDE SHANKS (Series D) with Alloy Steel Head

EVEREDE PART NUMBER	A	D1	D2	M	L2	INSERTS
	ANGLE	BAR DIA	SHANK DIA	MIN BORE	OAL	
CD3900	5	.625	.625	.719	6.000	TPGB-3 or TPGH-3 or TPGC-3
CD3905	0	.625	.625	.719	6.000	
CD3910	5	.625	.625	.719	10.000	
CD3915	0	.625	.625	.719	10.000	
CD4000	5	.750	.750	.844	6.000	
CD4005	0	.750	.750	.844	6.000	
CD4010	5	.750	.750	.844	10.000	
CD4015	0	.750	.750	.844	10.000	
CD4100	5	1.000	1.000	1.094	6.000	
CD4105	0	1.000	1.000	1.094	6.000	
CD4110	5	1.000	1.000	1.094	12.000	
CD4115	0	1.000	1.000	1.094	12.000	

See Inserts page 4

HEAVY METAL SHANKS (Series D)

EVEREDE PART NUMBER	A	D1	D2	M	L2	INSERTS
	ANGLE	BAR DIA	SHANK DIA	MIN BORE	OAL	
HD3900	5	.625	.625	.719	6.000	TPGB-3 or TPGH-3 or TPGC-3
HD3905	0	.625	.625	.719	6.000	
HD3910	5	.625	.625	.719	10.000	
HD3915	0	.625	.625	.719	10.000	
HD4000	5	.750	.750	.844	6.000	
HD4005	0	.750	.750	.844	6.000	
HD4010	5	.750	.750	.844	10.000	
HD4015	0	.750	.750	.844	10.000	
HD4100*	5	1.000	1.000	1.094	6.000	
HD4105*	0	1.000	1.000	1.094	6.000	
HD4110*	5	1.000	1.000	1.094	12.000	
HD4115*	0	1.000	1.000	1.094	12.000	

See Inserts page 4

*Quote upon request.

- Most bars are available left handed. Please add letter "L" after part number.
- Most bars are available coolant thru. Please add letter "CH" after part number.

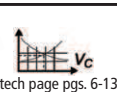

- All bars can be ordered with flats.
- See "BORING BAR ORDERING INFORMATION" pg. 27 for details.

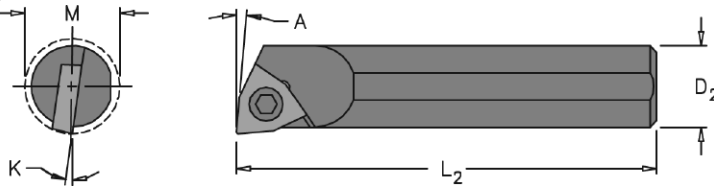

Bars come with flat as shown.
5° angle bars for facing and through hole boring.
0° angle for through hole boring and boring to shoulder.

ALLOY STEEL SHANKS (Series E)

EVEREDE PART NUMBER	A	K	D2	M	L2	INSERTS
	ANGLE	ANGLE	SHANK DIA	MIN BORE	OAL	
SE5010	5°	20°	.187	.230	2.500	WCCT-0 <small>See Inserts page 5</small>
SE5015	0°	20°	.187	.244	2.500	
SE6000	5°	17°	.250	.300	4.000	
SE6005	0°	17°	.250	.300	4.000	

CARBIDE SHANKS (Series E) with Alloy Steel Head

EVEREDE PART NUMBER	A	K	D2	M	L2	INSERTS
	ANGLE	ANGLE	SHANK DIA	MIN BORE	OAL	
CE5215	5°	20°	.187	.230	4.000	WCCT-0 <small>See Inserts page 5</small>
CE5220	0°	20°	.187	.244	4.000	
CE5225	5°	20°	.187	.230	6.000	
CE5230	0°	20°	.187	.244	6.000	
CE5300	5°	17°	.250	.290	4.000	
CE5305	0°	17°	.250	.300	4.000	
CE5310	5°	17°	.250	.290	6.000	
CE5315	0°	17°	.250	.300	6.000	

HEAVY METAL SHANKS (Series E)

EVEREDE PART NUMBER	A	K	D2	M	L2	INSERTS
	ANGLE	ANGLE	SHANK DIA	MIN BORE	OAL	
HE5215	5°	20°	.187	.230	4.000	WCCT-0 <small>See Inserts page 5</small>
HE5220	0°	20°	.187	.244	4.000	
HE5300	5°	17°	.250	.290	4.000	
HE5305	0°	17°	.250	.300	4.000	
HE5310	5°	17°	.250	.290	6.000	
HE5315	0°	17°	.250	.300	6.000	

- Most bars are available left handed. Please add letter "L" after part number.
- Most bars are available coolant thru. Please add letter "CH" after part number.

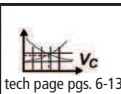

- See "BORING BAR ORDERING INFORMATION" pg. 27 for details.

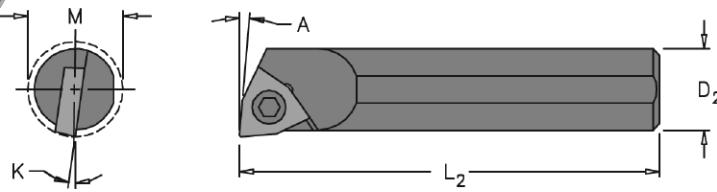

Bars come with flat as shown.
5° angle bars for facing and through hole boring.
0° angle for through hole boring and boring to shoulder.

ALLOY STEEL SHANKS (Series F)

EVEREDE PART NUMBER	A	K	D2	M	L2	INSERTS
	ANGLE	ANGLE	SHANK DIA	MIN BORE	OAL	
SF6100	5°	17°	.312	.360	4.000	WCGT-1 See Inserts page 5
SF6105	0°	17°	.312	.360	4.000	

CARBIDE SHANKS (Series F) with Alloy Steel Head

EVEREDE PART NUMBER	A	K	D2	M	L2	INSERTS
	ANGLE	ANGLE	SHANK DIA	MIN BORE	OAL	
CF6300	5°	17°	.312	.360	4.000	WCGT-1 See Inserts page 5
CF6305	0°	17°	.312	.360	4.000	
CF6310	5°	17°	.312	.360	6.000	
CF6315	0°	17°	.312	.360	6.000	

HEAVY METAL SHANKS (Series F)

EVEREDE PART NUMBER	A	K	D2	M	L2	INSERTS
	ANGLE	ANGLE	SHANK DIA	MIN BORE	OAL	
HF6300	5°	17°	.312	.360	4.000	WCGT-1 See Inserts page 5
HF6305	0°	17°	.312	.360	4.000	
HF6310	5°	17°	.312	.360	6.000	
HF6315	0°	17°	.312	.360	6.000	

INSERTS

CUTTING DATA

KITS & SETS

ANSI BORING BARS

SERIES BORING BARS

ROTATING TOOLS

<ul style="list-style-type: none"> Most bars are available left handed. Please add letter "L" after part number. Most bars are available coolant thru. Please add letter "CH" after part number. 	inserts p. 5	screws p. 59	wrenches p. 59	tech page pgs. 6-13	<ul style="list-style-type: none"> See "BORING BAR ORDERING INFORMATION" pg. 27 for details.
--	--------------	--------------	----------------	---------------------	---

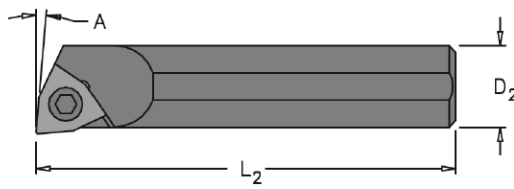
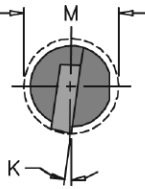

Bars come with flat as shown.
5° angle bars for facing and through hole boring.
0° angle for through hole boring and boring to shoulder.

ALLOY STEEL SHANKS (Series G)

EVEREDE PART NUMBER	A	K	D2	M	L2	INSERTS
	ANGLE	ANGLE	SHANK DIA	MIN BORE	OAL	
SG6700	5°	12°	.375	.438	5.000	WCGT-2 <small>See Inserts page 5</small>
SG6705	0°	12°	.375	.438	5.000	
SG6800	5°	10°	.500	.563	6.000	
SG6805	0°	10°	.500	.563	6.000	

CARBIDE SHANKS (Series G) with Alloy Steel Head

EVEREDE PART NUMBER	A	K	D2	M	L2	INSERTS
	ANGLE	ANGLE	SHANK DIA	MIN BORE	OAL	
CG6900	5°	12°	.375	.438	6.000	WCGT-2 <small>See Inserts page 5</small>
CG6905	0°	12°	.375	.438	6.000	
CG6910	5°	12°	.375	.438	10.000	
CG6915	0°	12°	.375	.438	10.000	
CG7000	5°	10°	.500	.563	6.000	
CG7005	0°	10°	.500	.563	6.000	
CG7010	5°	10°	.500	.563	10.000	
CG7015	0°	10°	.500	.563	10.000	

HEAVY METAL SHANKS (Series G)

EVEREDE PART NUMBER	A	K	D2	M	L2	INSERTS
	ANGLE	ANGLE	SHANK DIA	MIN BORE	OAL	
HG6900	5°	12°	.375	0.438	6.000	WCGT-2 <small>See Inserts page 5</small>
HG6905	0°	12°	.375	0.438	6.000	
HG6910	5°	12°	.375	0.438	10.000	
HG6915	0°	12°	.375	0.438	10.000	
HG7000	5°	10°	.500	0.563	6.000	
HG7005	0°	10°	.500	0.563	6.000	
HG7010	5°	10°	.500	0.563	10.000	
HG7015	0°	10°	.500	0.563	10.000	

<ul style="list-style-type: none"> • Most bars are available left handed. Please add letter "L" after part number. • Most bars are available coolant thru. Please add letter "CH" after part number. 	inserts p. 5	screws p. 59	wrenches p. 59	tech page pgs. 6-13	<ul style="list-style-type: none"> • See "BORING BAR ORDERING INFORMATION" pg. 27 for details.
--	--------------	--------------	----------------	---------------------	---

INSERTS
CUTTING DATA
KITS & SETS
ANSI BORING BARS
SERIES BORING BARS
ROTATING TOOLS

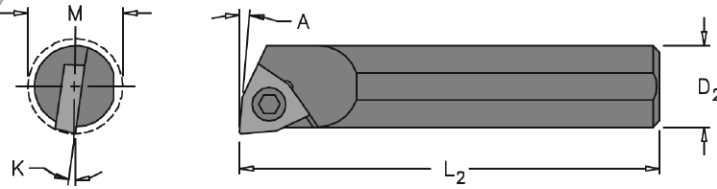

Bars come with flat as shown.
 5° angle bars for facing and through hole boring.
 0° angle for through hole boring and boring to shoulder.

ALLOY STEEL SHANKS (Series H)

EVEREDE PART NUMBER	A	K	D2	M	L2	INSERTS
	ANGLE	ANGLE	BAR DIA	MIN BORE	OAL	
SH7100	5°	14°	.500	.625	2.500	WCGT-3
SH7105	0°	14°	.500	.625	2.500	
SH7400	5°	14°	.500	.625	6.000	
SH7405	0°	14°	.500	.625	6.000	
SH7110	5°	12°	.625	.719	4.000	
SH7115	0°	12°	.625	.719	4.000	
SH7500	5°	12°	.625	.719	7.000	
SH7505	0°	12°	.625	.719	7.000	
SH7200	5°	10°	.750	.844	4.000	
SH7205	0°	10°	.750	.844	4.000	
SH7600	5°	10°	.750	.844	8.000	
SH7605	0°	10°	.750	.844	8.000	
SH7300	5°	8°	1.000	1.094	5.000	
SH7305	0°	8°	1.000	1.094	5.000	
SH7700	5°	8°	1.000	1.094	10.000	
SH7705	0°	8°	1.000	1.094	10.000	
SH7800	5°	6°	1.250	1.344	12.000	
SH7805	0°	6°	1.250	1.344	12.000	

See Inserts page 5

CARBIDE SHANKS (Series H) with Alloy Steel Head

EVEREDE PART NUMBER	A	K	D2	M	L2	INSERTS
	ANGLE	ANGLE	SHANK DIA	MIN BORE	OAL	
CH7900	5°	12°	.625	.719	6.000	WCGT-3
CH7905	0°	12°	.625	.719	6.000	
CH7910	5°	12°	.625	.719	10.000	
CH7915	0°	12°	.625	.719	10.000	
CH8000	5°	10°	.750	.844	6.000	
CH8005	0°	10°	.750	.844	6.000	
CH8010	5°	10°	.750	.844	10.000	
CH8015	0°	10°	.750	.844	10.000	
CH8100	5°	8°	1.000	1.094	6.000	
CH8105	0°	8°	1.000	1.094	6.000	
CH8110	5°	8°	1.000	1.094	12.000	
CH8115	0°	8°	1.000	1.094	12.000	

See Inserts page 5

- Most bars are available left handed. Please add letter "L" after part number.
- Most bars are available coolant thru. Please add letter "CH" after part number.

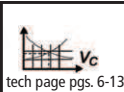

- See "BORING BAR ORDERING INFORMATION" pg. 27 for details.

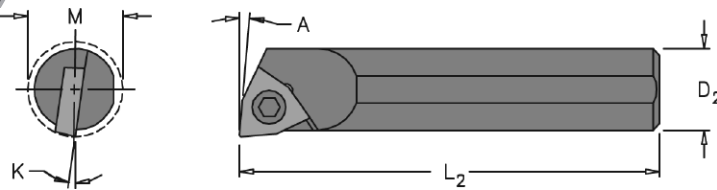

Bars come with flat as shown.
5° angle bars for facing and through hole boring.
0° angle for through hole boring and boring to shoulder.

HEAVY METAL SHANKS (Series H)

EVEREDE PART NUMBER	A	K	D2	M	L2	INSERTS
	ANGLE	ANGLE	SHANK DIA	MIN BORE	OAL	
HH7900	5°	12°	.625	0.719	6.000	WCGT-3
HH7905	0°	12°	.625	0.719	6.000	
HH7910	5°	12°	.625	0.719	10.000	
HH7915	0°	12°	.625	0.719	10.000	
HH8000	5°	10°	.750	0.844	6.000	
HH8005	0°	10°	.750	0.844	6.000	
HH8010	5°	10°	.750	0.844	10.000	
HH8015	0°	10°	.750	0.844	10.000	
HH8100	5°	8°	1.000	1.094	6.000	
HH8105	0°	8°	1.000	1.094	6.000	
HH8110	5°	8°	1.000	1.094	12.000	
HH8115	0°	8°	1.000	1.094	12.000	

See Inserts page 5

INSERTS

CUTTING DATA

KITS & SETS

ANSI BORING BARS

SERIES BORING BARS

ROTATING TOOLS

<ul style="list-style-type: none"> • Most bars are available left handed. Please add letter "L" after part number. • Most bars are available coolant thru. Please add letter "CH" after part number. 	inserts p. 5	screws p. 59	wrenches p. 59	tech page pgs. 6-13	<ul style="list-style-type: none"> • See "BORING BAR ORDERING INFORMATION" pg. 27 for details.
--	--------------	--------------	----------------	---------------------	---

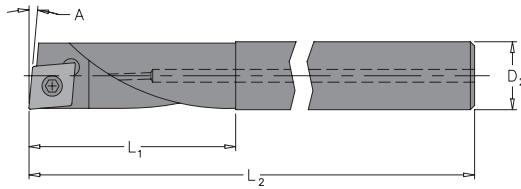
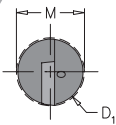

Closely related min bore/bar diameter.
Enhanced chip evacuation.
Better rigidity. Better tool life.
Coolant through standard.

SOLID HEAVY METAL SHANKS (Series FL)

EVEREDE PART NUMBER	A/K	D1	D2	M	L1	L2	INSERTS
	LEAD	BAR DIA	SHANK	MIN BORE	FLUTE LENGTH	OAL	
HA1150CH-FL	5°	.200	.250	.220	.880	3.000	CDCC or CDCD or CDCH <small>See Inserts page 2</small>
HA1160CH-FL	5°	.230	.250	.260	1.000	3.000	

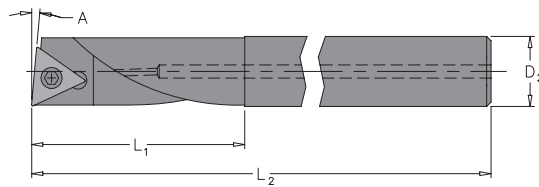
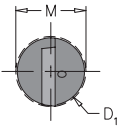

Closely related min bore/bar diameter.
Enhanced chip evacuation.
Better rigidity. Better tool life.
Coolant through standard.

EVEREDE PART NUMBER	A/K	D1	D2	M	L1	L2	INSERTS
	LEAD	BAR DIA	SHANK	MIN BORE	FLUTE LENGTH	OAL	
HB1250CH-FL	5°	.292	.312	.312	1.250	3.000	TDAB or TDAC <small>See Inserts page 3</small>
HB1260CH-FL	5°	.355	.375	.375	1.500	4.000	
HC1350CH-FL	5°	.480	.500	.500	2.000	4.000	TPGB-2 or TPGC-2 or TPGH-2 <small>See Inserts page 3</small>
HC1360CH-FL	5°	.605	.625	.625	2.500	6.000	
HD1450CH-FL	5°	.730	.750	.750	3.000	6.000	TPGB-3 or TPGC-3 or TPGH-3 <small>See Inserts pages 4</small>
HD1460CH-FL	5°	.980	1.000	1.000	4.000	8.000	

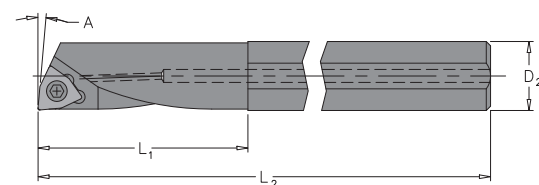
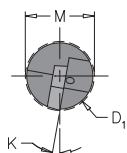

Closely related min bore/bar diameter.
Enhanced chip evacuation.
Better rigidity. Better tool life.
Coolant through standard.

EVEREDE PART NUMBER	A/K	D1	D2	M	L1	L2	INSERTS
	LEAD	BAR DIA	SHANK	MIN BORE	FLUTE LENGTH	OAL	
HE5050CH-FL*	5°	.200	.250	.220	.880	3.000	WCGT-0 <small>See Inserts page 5</small>
HE5060CH-FL*	5°	.230	.250	.250	1.000	3.000	
HE5070CH-FL*	5°	.292	.312	.312	1.250	3.000	
HG6050CH-FL*	5°	.355	.375	.375	1.500	4.000	WCGT-2 <small>See Inserts page 5</small>
HG6060CH-FL*	5°	.480	.500	.500	2.000	4.000	
HH7050CH-FL*	5°	.605	.625	.625	2.500	6.000	WCGT-3 <small>See Inserts page 5</small>
HH7060CH-FL*	5°	.730	.750	.750	3.000	6.000	
HH7070CH-FL*	5°	.980	1.000	1.000	4.000	8.000	

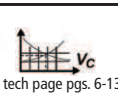

* Bars have flats as standard.

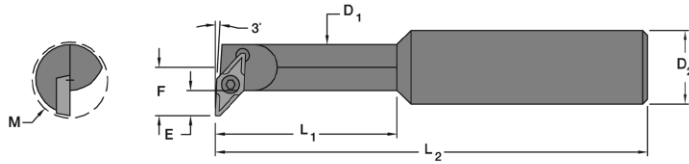

Left-hand bars use left-hand inserts and right-hand bars use right-hand inserts.
 Right-hand bars are shown.

ALLOY STEEL SHANKS (Series PB)

EVEREDE PART NUMBER	D1	D2	M	L1	L2	E	F	INSERTS
	BAR DIA	SHANK	MIN BORE	BAR LENGTH	OAL	INSERT OVERHANG	CENTER OFFSET	
SPB2000R	.312	.500	.520	1.250	4.000	.175	.331	XPGT-1 See Inserts page 5
SPB2010R	.375	.500	.580	1.500	4.000	.175	.362	
SPB2020R	.438	.500	.640	1.750	4.000	.175	.394	
screw #19041 wrench #19551								
SPB2100R	.438	.625	.760	1.750	5.000	.292	.511	VPGT-2 See Inserts page 4
SPB2110R	.563	.750	.880	2.250	5.000	.292	.573	
SPB2120R	.688	1.000	1.100	2.750	6.000	.292	.636	
screw #19035 wrench #19552								

METRIC ALLOY STEEL SHANKS (Series PB)

EVEREDE PART NUMBER	D1	D2	M	L1	L2	E	F	INSERTS
	BAR DIA	SHANK	MIN BORE	BAR LENGTH	OAL	INSERT OVERHANG	CENTER OFFSET	
SPB2400R	7.9mm	12mm	13.2mm	31mm	102	4.5mm	8.4mm	XPGT-1 See Inserts page 5
SPB2410R	9.5mm	12mm	13.2mm	38mm	102	4.5mm	9.2mm	
SPB2420R	11.1mm	12mm	16.3mm	44mm	102	4.5mm	10.0mm	
screw #19041 wrench #19551								
SPB2500R	11.1mm	16mm	19.3mm	44mm	127	7.4mm	13.0mm	VPGT-2 See Inserts page 4
SPB2510R	14.3mm	20mm	22.4mm	57mm	127	7.4mm	14.6mm	
SPB2520R	17.5mm	25mm	27.9mm	68mm	152	7.4mm	16.2mm	
screw #19035 wrench #19552								

· For Left-handed bars, replace "R" at end of part number with "L".

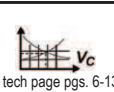

INSERTS
 CUTTING DATA
 KITS & SETS
 ANSI BORING BARS
 SERIES BORING BARS
 ROTATING TOOLS

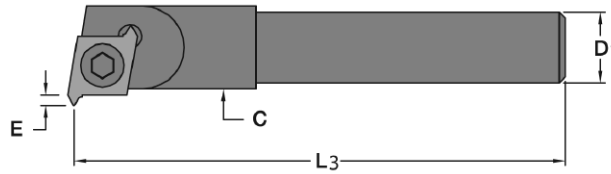
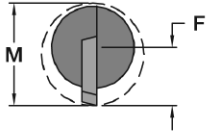

SERIES TH
MINIMUM
THREADING
DIAMETER
0.272 TO 0.312"

MIN. T.P.I.: 35
MIN. METRIC PITCH: 0.8MM

ALLOY STEEL SHANKS (Series TH)

EVEREDE PART NUMBER	D1	D2	M	L3	E	F	INSERTS
	HEAD DIAMETER	SHANK DIAMETER	MIN THREAD DIAMETER	LENGTH	MAX THREAD DEPTH	CENTER OFFSET	
STH1000	.219	.187	.272	2.500	.025	.154	CDCT-02 See Inserts page 2
STH1010	.260	.250	.312	3.000	.025	.175	

CARBIDE SHANKS (Series TH)

EVEREDE PART NUMBER	D1	D2	M	L3	E	F	INSERTS
	HEAD DIAMETER	SHANK DIAMETER	MIN THREAD DIAMETER	LENGTH	MAX THREAD DEPTH	CENTER OFFSET	
CTH1000	.219	.187	.272	4.000	.025	.154	CDCT-02 See Inserts page 2
CTH1010	.260	.250	.312	4.000	.025	.175	

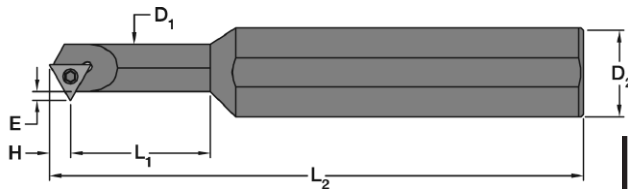
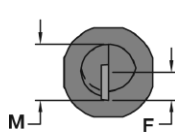
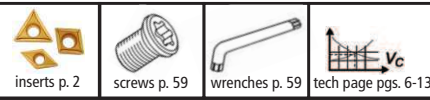

SERIES TH
MINIMUM
THREADING
DIAMETER
0.312 TO 0.593"

MIN. T.P.I.: 10
MIN. METRIC PITCH: 3.0MM

ALLOY STEEL SHANKS (Series TH)

EVEREDE PART NUMBER	D1	D2	M	L1	L2	E	F	H	INSERTS
	HEAD DIAMETER	SHANK DIAMETER	MIN THREAD DIAMETER	THREAD DEPTH	OVERALL LENGTH	INSERT OVERHANG	CENTER OFFSET	SHOULDER CLEARANCE	
STH1100	.250	.625	.312	.750	4.000	0.60	.155	.138	TBEB-02F See Inserts page 3
STH1110	.250	.625	.312	1.250	4.000		.155		
STH1120	.312	.625	.372	.938	4.000		.186		
STH1130	.312	.625	.372	1.500	4.000		.186		
STH1140	.375	.625	.468	1.125	4.000	.093	.234	216	TBEB-04F See Inserts page 3
STH1150	.375	.625	.468	1.875	4.000		.234		
STH1160	.500	.625	.593	1.500	4.000		.297		

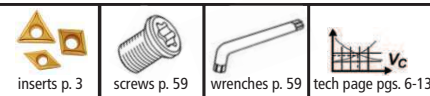

INSERTS
 CUTTING DATA
 KITS & SETS
 ANSI BORING BARS
 SERIES BORING BARS
 ROTATING TOOLS

SERIES RCH
 MINIMUM BORE
 0.394 TO 0.909"

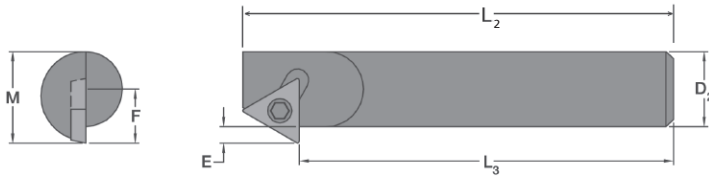

ALLOY STEEL SHANKS (Series RCH)

EVEREDE PART NUMBER	D2	M	L2	L3	E	F	INSERTS
	SHANK DIAMETER	MINIMUM BORE	OAL	LENGTH	INSERT OVERHANG	CENTER OFFSET	
SRCH1000	.312	.394	3.720	3.500	.062	.223	TDAB See Inserts page 3
SRCH1010	.375	.492	4.850	4.500	.092	.287	TPGB2 & TPGH2 See Inserts page 3
SRCH1020	.500	.645	5.350	5.000	.125	.380	
SRCH1030	.625	.909	5.540	5.000	.264	.581	TPGH3 & TPGB3 See Inserts pages 4

REVERSE CHAMFER BARS

SERIES RCH
 30° ANGLE
 MINIMUM BORE
 0.407 TO 1.205"

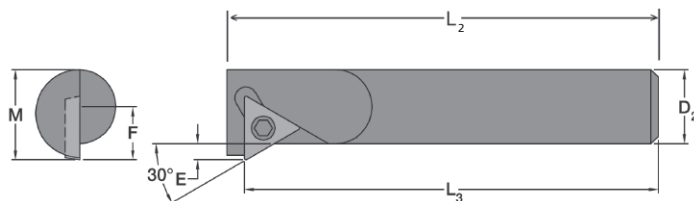

ALLOY STEEL SHANKS (Series RCH)

EVEREDE PART NUMBER	D2	M	L2	L3	E	F	INSERTS
	SHANK DIAMETER	MINIMUM BORE	OAL	LENGTH	INSERT OVERHANG	CENTER OFFSET	
SRCH1100	.312	.407	3.600	3.500	.075	.236	TDAB See Inserts page 3
SRCH1110	.375	.525	5.100	5.000	.125	.320	TPGB2 & TPGH2 See Inserts page 3
SRCH1120	.500	.645	6.100	6.000	.125	.380	
SRCH1130	.625	.827	7.100	7.000	.182	.499	TPGH3 & TPGB3 See Inserts pages 4
SRCH1140	.750	.955	8.100	8.000	.182	.562	
SRCH1150	1.000	1.205	10.100	10.000	.182	.687	

<p>inserts pgs. 3-4</p>	<p>screws p. 59</p>	<p>wrenches p. 59</p>	<p>tech page pgs. 6-13</p>
-------------------------	---------------------	-----------------------	----------------------------

INSERTS
 CUTTING DATA
 KITS & SETS
 ANSI BORING BARS
 SERIES BORING BARS
 ROTATING TOOLS

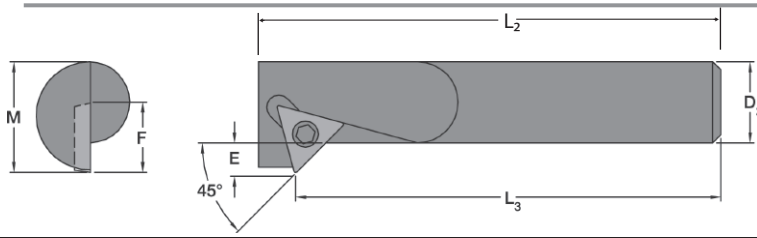

SERIES RCH
45° ANGLE
MINIMUM BORE
0.525 TO 1.205"

ALLOY STEEL SHANKS (Series RCH)

EVEREDE PART NUMBER	D2	M	L2	L3	E	F	INSERTS
	SHANK DIAMETER	MINIMUM BORE	OAL	LENGTH	INSERT OVERHANG	CENTER OFFSET	
SRCH1200	.312	.407	3.620	3.500	.075	.236	TDAB <small>See Inserts page 3</small>
SRCH1210	.375	.525	5.250	5.000	.125	.320	TPGB2 & TPGH2 <small>See Inserts page 3</small>
SRCH1220	.500	.827	6.200	6.000	.125	.380	
SRCH1230	.625	.909	7.760	7.000	.182	.499	TPGH3 & TPGB3 <small>See Inserts pages 4</small>
SRCH1240	.750	.955	6.250	8.000	.182	.562	
SRCH1250	1.000	1.205	10.260	10.000	.182	.687	

REVERSE CHAMFER BARS

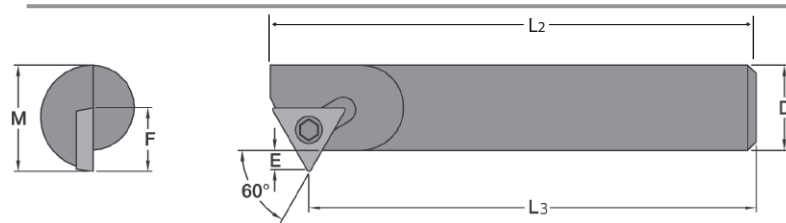

SERIES RCH
60° ANGLE
MINIMUM BORE
0.407 TO 1.205"

ALLOY STEEL SHANKS (Series RCH)

EVEREDE PART NUMBER	D	M	L2	L3	E	F	INSERTS
	SHANK DIAMETER	MINIMUM BORE	OAL	LENGTH	INSERT OVERHANG	CENTER OFFSET	
SRCH1300	.312	.407	3.630	3.500	.075	.236	TDAB <small>See Inserts page 3</small>
SRCH1310	.375	.525	5.210	5.000	.125	.320	TPGB2 & TPGH2 <small>See Inserts page 3</small>
SRCH1320	.500	.645	6.210	6.000	.125	.380	
SRCH1330	.625	.827	7.320	7.000	.182	.499	TPGH3 & TPGB3 <small>See Inserts pages 4</small>
SRCH1340	.750	.955	8.320	8.000	.182	.562	
SRCH1350	1.000	1.205	10.320	10.000	.182	.687	

INSERTS

CUTTING DATA

KITS & SETS

ANSI BORING BARS

SERIES BORING BARS

ROTATING TOOLS

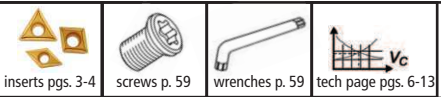

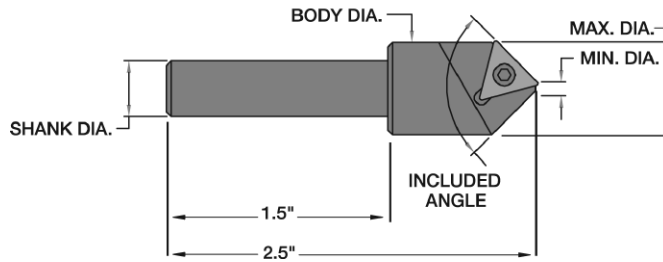

Inserts sold separately.
For use in variable speed machines.

COUNTERSINKS WITH STRAIGHT SHANKS (Series IND)

EVEREDE PART NUMBER	INCLUDED ANGLE	BODY DIAMETER	SHANK DIAMETER	MAXIMUM DIAMETER	MINIMUM DIAMETER	INSERT
IND-15-6-125	60°	1/2	3/8	.463	.125	TPGH-215 See Inserts page 3
IND-16-8-125	82°	5/8	3/8	.583		
IND-16-9-125	90°	5/8	3/8	.621		
IND-17-1-125	100°	3/4	1/2	.719		
IND-18-2-125	120°	7/8	1/2	.741		
IND-18-3-125	130°	7/8	1/2	.771		
IND-16-6-250	60°	5/8	3/8	.588	.250	
IND-17-8-250	82°	3/4	1/2	.708		
IND-17-9-250	90°	3/4	1/2	.746		
IND-18-1-250	100°	7/8	1/2	.844		
IND-19-2-250	120°	1	1/2	.866		
IND-19-3-250	130°	1	1/2	.896		
IND-17-6-375	60°	3/4	1/2	.713	.375	
IND-18-8-375	82°	7/8	1/2	.833		
IND-18-9-375	90°	7/8	1/2	.871		
IND-19-1-375	100°	1	1/2	.969		
IND-11.1-2-375	120°	1-1/8	1/2	.991		
IND-11.1-3-375	130°	1-1/8	1/2	1.021		
IND-18-6-500	60°	7/8	1/2	.838	.500	
IND-19-8-500	82°	1	1/2	.958		
IND-11.1-9-500	90°	1-1/8	1/2	.996		
IND-11.1-1-500	100°	1-1/8	1/2	1.094		
IND-11.2-2-500	120°	1-1/4	1/2	1.116		
IND-11.2-3-500	130°	1-1/4	1/2	1.145		

INSERTS

CUTTING DATA

KITS & SETS

 ANSI
BORING BARS

 SERIES
BORING BARS

ROTATING TOOLS

- Metric sizes available.
- Sets are available. See page 57.



inserts p. 3



screws p. 59



wrenches p. 59

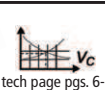

tech page pgs. 6-13

- Special angles available. See custom tooling at www.everede.net

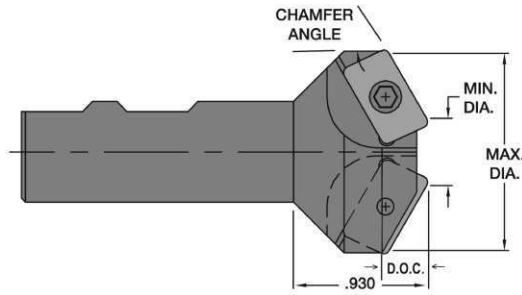

Inserts sold separately.

CHAMFERMILLS WITH WELDON SHANKS (Series CHM)

EVEREDE PART NUMBER	MIN DIA	MAX DIA	WELDON SHANK	CHAMFER ANGLE	NUMBER OF FLUTES	DEPTH OF CUT	OVERALL LENGTH	INSERT
CHM-750-30	.750	1.303	3/4	30°	2	.479	3.000	APLT-347 See Inserts page 2
CHM-688-41	.688	1.414	3/4	41°		.418		
CHM-688-45	.688	1.471	3/4	45°		.391		
CHM-500-60	.500	1.458	3/4	60°		.277		
CHM-1.000-30	1.000	1.553	1	30°	3	.479	3.200	
CHM-938-41	.938	1.664	1	41°		.418		
CHM-938-45	.938	1.721	1	45°		.391		
CHM-750-60	.750	1.708	1	60°		.277		
CHM-1.250-30	1.250	1.803	1-1/4	30°	3	.479	3.200	
CHM-1.188-41	1.188	1.914	1-1/4	41°		.418		
CHM-1.188-45	1.188	1.971	1-1/4	45°		.391		
CHM-1.000-60	1.000	1.958	1-1/4	60°		.277		
CHM-1.500-30	1.500	2.053	1-1/2	30°	3	.479	3.600	
CHM-1.438-41	1.438	2.164	1-1/2	41°		.418		
CHM-1.438-45	1.438	2.221	1-1/2	45°		.391		
CHM-1.250-60	1.250	2.208	1-1/2	60°		.277		

- Metric sizes available.
- Sets are available. See page 57.

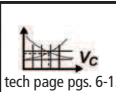

- Special angles available. See custom tooling at www.everede.net

INSERTS
 CUTTING DATA
 KITS & SETS
 ANSI BORING BARS
 SERIES BORING BARS
 ROTATING TOOLS

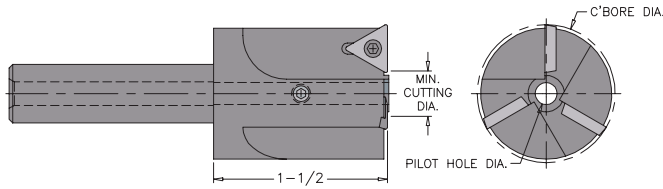

Pilots and inserts sold separately.
 See page 58 for pilot ordering information.
 All tools have 3 flutes.
 Overall length is 3.2"

PILOTED COUNTERBORES (Series INCB)

EVEREDE PART NUMBER	COUNTERBORE DIAMETER	SHANK DIAMETER	MINIMUM CUT DIAMETER	PILOT HOLE DIAMETER	INSERT
INCB-1.000-188S	1	1/2	.214	3/16	TPGH-215 See Inserts page 3
INCB-1.062-188S	1-1/16	1/2	.276	3/16	
INCB-1.125-188S	1-1/8	1/2	.337	3/16	
INCB-1.188-188S	1-3/16	1/2	.402	3/16	
INCB-1.250-312S	1-1/4	1/2	.464	5/16	
INCB-1.312-312S	1-5/16	1/2	.526	5/16	
INCB-1.375-312S	1-3/8	1/2	.589	5/16	
INCB-1.438-312S	1-7/16	1/2	.652	5/16	
INCB-1.500-312S	1-1/2	3/4	.714	5/16	
INCB-1.562-312S	1-9/16	3/4	.776	5/16	
INCB-1.625-312S	1-5/8	3/4	.839	5/16	
INCB-1.688-312S	1-11/16	3/4	.902	5/16	
INCB-1.750-438S	1-3/4	3/4	.964	7/16	
INCB-1.812-438S	1-13/16	3/4	1.026	7/16	
INCB-1.875-438S	1-7/8	3/4	1.089	7/16	
INCB-1.938-438S	1-15/16	3/4	1.152	7/16	
INCB-2.000-438S	2	1	1.214	7/16	

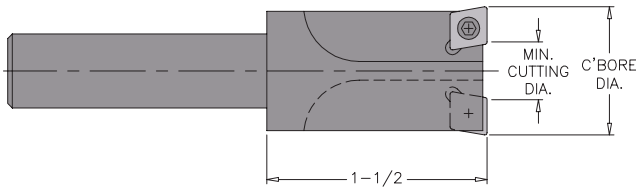

Inserts sold separately.
 All tools have 2 flutes and 1/2 shank.
 Overall length is 3.2"

PILOTLESS COUNTERBORES (Series INCB)

EVEREDE PART NUMBER	COUNTERBORE DIAMETER	MINIMUM CUT DIAMETER	INSERT
INCB-625S	5/8	.148	CCGT-21.51 See Inserts page 2
INCB-688S	11/16	.211	
INCB-750S	3/4	.273	
INCB-812S	13/16	.335	
INCB-875S	7/8	.398	
INCB-938S	15/16	.461	

· Metric sizes only available as special order.

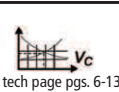

· Specials available by request.



Single effective flute. Not center cutting.
See recommended pre-drill size.
Other grades available on request.
Match J & K insert grades when ordering.

SAE1926/MS16142 (Series PC) with coolant thru

EVEREDE PART NUMBER	PORT SIZE	PRE DRILL SIZE	TUBE NUMBER	A	B	C	D	E	F ±1°
				DIA.	DIA.	DIA.			
IFPC-438-20	7/16-20	0.37	4	0.389	0.490	0.827	0.102	0.551	12°
IFPC-500-20	1/2-20	0.44	5	0.452	0.553	0.906	0.102	0.551	12°
IFPC-562-18	9/16-18	0.48	6	0.509	0.618	0.984	0.106	0.610	12°
IFPC-750-16	3/4-16	0.67	8	0.689	0.813	1.181	0.106	0.689	15°
IFPC-875-14	7/8-14	0.78	10	0.806	0.945	1.339	0.106	0.787	15°
IFPC-1.062-12	1-1/16-12	0.95	12	0.981	1.150	1.614	0.138	0.906	15°
IFPC-1.188-12	1-3/16-12	1.09	14	1.106	1.276	1.772	0.138	0.906	15°
IFPC-1.312-12	1-5/16-12	1.21	16	1.231	1.400	1.929	0.138	0.906	15°
IFPC-1.625-12	1-5/8-12	1.53	20	1.544	1.715	2.283	0.138	0.906	15°
IFPC-1.875-12	1-7/8-12	1.78	24	1.794	1.965	2.559	0.138	0.906	15°

EVEREDE PART NUMBER	G	H & I	J1	J2	K1	K2	L1	L2
	DIA .0005-.0010	LENGTH	INSERT	INSERT SCREW	INSERT	INSERT SCREW	INSERT	INSERT SCREW
IFPC-438-20	3/4	2-1/2	WCGT-208	19035	31096	19035	CCGT-21.51	19035
IFPC-500-20	3/4	2-1/2	WCGT-208	19035	31096	19035	CCGT-21.51	19035
IFPC-562-18	3/4	2-1/2	WCGT-208	19035	31096	19035	CCGT-21.51	19035
IFPC-750-16	3/4	2-1/2	WCGT-208	19035	31098	19035	TPGH-215	19074
IFPC-875-14	3/4	2-1/2	WCGT-315	19043	31098	19035	TPGH-215	19074
IFPC-1.062-12	1	3	WCGT-315	19043	31099	19507	TPGH-215	19074
IFPC-1.188-12	1	3	WCGT-315	19043	31099	19507	TPGH-315	19043
IFPC-1.312-12	1	3	WCGT-315	19043	31099	19507	TPGH-315	19043
IFPC-1.625-12	1-1/4	3	TPGH-315	19043	31099	19507	TPGH-315	19043
IFPC-1.875-12	1-1/4	3	TPGH-315	19043	31099	19507	TPGH-315	19043

EVEREDE PART NO.	IC	T	COATED GRADES					UNCOATED GRADES					CERMET	TIPPED	Holder Series	
			PVD		CVD			C8	C5	C3	C2	C1	C7	PCD		CBN
			TiN	TiAlN	TiN	TiN	TiN									
31096	.250	.094	CV7	CVM2	TL120	CV6	MC32	CS7	CS6	CM2	CS2	MU12	CT7	PCD	CBN	PC
31098	.250	.094														
31099	.375	.125														

○ = outgoing item

<ul style="list-style-type: none"> See Inserts pages for CCGT-21.51, TPGH, WCGT. Tech data page 6. 	inserts pgs. 2-5	screws p. 59	wrenches p. 59	tech page pgs. 6-13	<ul style="list-style-type: none"> Screw #19035 uses wrench # 19552. Screw #19043 uses wrench #19555. Screw #19507 uses wrench #19554.
--	------------------	--------------	----------------	---------------------	---

INSERTS

CUTTING DATA

KITS & SETS

ANSI BORING BARS

SERIES BORING BARS

ROTATING TOOLS

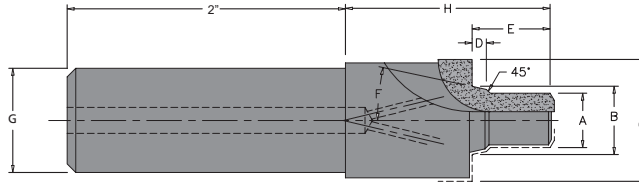

All cutters have 3 carbide tipped flutes.

SAE J1926/MS16142 (Series PC) with coolant thru

EVEREDE PART NUMBER	PORT SIZE	PRE DRILL SIZE	TUBE #	A	B ± .002	C	D ± .008	E	F	G	H
				DIA.	DIA.	MIN. DIA.	LENGTH	MIN. LENGTH	ANGLE	-.0005 -.0010	LENGTH
CTPC-312-24	5/16-24	0.25	2	0.272	0.360	0.669	0.083	0.472	12°	1/2	1-1/2
CTPC-375-24	3/8-24	0.31	3	0.335	0.423	0.748	0.083	0.472	12°	1/2	1-1/2
CTPC-438-20	7/16-20	0.37	4	0.389	0.490	0.827	0.102	0.551	12°	1/2	1-1/2
CTPC-500-20	1/2-20	0.44	5	0.452	0.553	0.906	0.102	0.551	12°	1/2	1-1/2
CTPC-562-18	9/16-18	0.48	6	0.509	0.618	0.984	0.106	0.610	12°	1/2	1-1/2
CTPC-750-16	3/4-16	0.67	8	0.689	0.813	1.181	0.106	0.689	15°	3/4	1-1/2
CTPC-875-14	7/8-14	0.78	10	0.806	0.945	1.339	0.106	0.787	15°	3/4	2
CTPC-1.062-12	1 1/16-12	0.95	12	0.981	1.150	1.614	0.138	0.906	15°	3/4	2
CTPC-1.188-12	1 3/16-12	1.09	14	1.106	1.276	1.772	0.138	0.906	15°	3/4	2
CTPC-1.312-12	1 5/16-12	1.21	16	1.231	1.400	1.929	0.138	0.906	15°	3/4	2
CTPC-1.625-12	1 5/8-12	1.53	20	1.544	1.715	2.284	0.138	0.906	15°	3/4	2
CTPC-1.875-12	1 7/8-12	1.78	24	1.794	1.965	2.559	0.138	0.906	15°	3/4	2

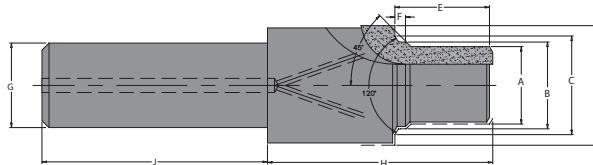

All cutters have 3 carbide tipped flutes.

SAE AS5202/MS33649 (Series PC) with coolant thru

EVEREDE PART NUMBER	PORT SIZE (UNJF & UNJ)	PRE DRILL SIZE	TUBE #	A	B +.005 -.000	C +.015 -.000	D	E	G	H	J
				DIA.	DIA.	DIA.	MIN. DIA.	MIN. LENGTH	-.0005 -.0010	LENGTH	LENGTH
CTPC-375-24-649	3/8-24	0.31	3	.335	.390	.500	.688	.588	1/2	1-1/2	2
CTPC-438-20-649	7/16-20	0.37	4	.389	.454	.562	.750	.661	1/2	1-1/2	2
CTPC-500-20-649	1/2-20	0.43	5	.452	.517	.625	.812	.661	1/2	1-1/2	2
CTPC-562-18-649	9/16-18	0.49	6	.515	.580	.688	.875	.714	1/2	1-1/2	2
CTPC-625-18-649	5/8-18	0.55	7	.578	.643	.750	.938	.730	1/2	1-1/2	2
CTPC-750-16-649	3/4-16	0.66	8	.689	.769	.875	1.062	.839	3/4	1-1/2	2
CTPC-875-14-649	7/8-14	0.77	10	.797	.896	1.000	1.188	.935	3/4	2	2
CTPC-1.062-12-649	1 1/16-12	0.96	12	.981	1.086	1.234	1.438	1.069	3/4	2	2
CTPC-1.188-12-649	1 3/16-12	1.08	14	1.106	1.211	1.362	1.562	1.069	3/4	2	2
CTPC-1.312-12-649	1 5/16-12	1.21	16	1.231	1.336	1.487	1.688	1.069	3/4	2	2
CTPC-1.625-12-649	1 5/8-12	1.52	20	1.544	1.648	1.800	2.000	1.121	3/4	2	2
CTPC-1.875-12-649	1 7/8-12	1.77	24	1.794	1.898	2.050	2.250	1.132	3/4	2	2

MATERIAL APPLICATIONS RECOMMENDATIONS FOR INDEXABLE PORT CONTOUR CUTTERS

MATERIAL	RPM / IPR	7/16-20	1/2-20	9/16-18	3/4-16	7/8-14	1 1/6-12	1 3/16-12	1 5/16-12	1 5/8-12	1 7/8-12
STEEL (120-180 BHN)	RPM	3300	2900	2600	2000	1800	1500	1400	1200	1000	900
	IPR	.003	.003	.003	.004	.004	.005	.005	.005	.006	.006
STEEL (180-240 BHN)	RPM	3000	2650	2350	1800	1600	1300	1200	1100	950	850
	IPR	.003	.003	.003	.004	.004	.005	.005	.005	.006	.006
STEEL (240-300 BHN)	RPM	2650	2350	2100	1600	1500	1200	1100	1000	900	750
	IPR	.003	.003	.003	.004	.004	.005	.005	.005	.006	.006
300 SERIES STAINLESS	RPM	2000	1750	1600	1200	1000	900	800	700	600	500
	IPR	.003	.003	.003	.004	.004	.005	.005	.005	.006	.006
400 SERIES STAINLESS	RPM	2300	2050	1850	1400	1300	1100	1000	900	750	700
	IPR	.003	.003	.003	.004	.004	.005	.005	.005	.006	.006
17-4 & PH SERIES S.S.	RPM	2150	1900	1700	1300	1200	1000	900	800	700	600
	IPR	.003	.003	.003	.004	.004	.005	.005	.005	.006	.006
CAST IRON	RPM	2650	2350	2100	1600	1500	1200	1100	1000	900	750
	IPR	.004	.004	.004	.005	.005	.006	.006	.006	.008	.008
ALUMINUM	RPM	4800	4250	3800	2900	2800	2700	2600	2400	2000	1800
	IPR	.004	.004	.004	.005	.005	.006	.006	.006	.006	.006
TITANIUM	RPM	1150	1000	900	700	600	500	450	400	350	300
	IPR	.003	.003	.003	.004	.004	.005	.005	.005	.006	.006
HIGH TEMP ALLOY	RPM	1150	1000	900	700	600	500	450	400	350	300
	IPR	.003	.003	.003	.004	.004	.005	.005	.005	.006	.006

Speeds based on uncoated inserts.

IPR based on single cutting edge. For multiple flute tools, multiply by the number of flutes.

Speeds and feeds will vary upon application.

Please call us for specific application cutting parameters. Add approximately 30% to speeds for coated inserts.



inserts pgs. 2-5



screws p. 59



wrenches p. 59

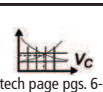

tech page pgs. 6-13

INSERTS

CUTTING DATA

KITS & SETS

ANSI BORING BARS

SERIES BORING BARS

ROTATING TOOLS

HARDWARE					
HOLDER SERIES	INSERT	TORX SCREW	SCREW DESCRIPTION	TORX WRENCH	Torque "IN-LBS"
A FL	CDCD CDCC CDCH	19501	1-72 OVAL X .090 LG.-T6	19551	4-5
B FL RCH	TDAB TDAC	19503	2-56 OVAL X .110 LG. -T7	19552	7-8
C FL	TPGB-2 TPGC-2	19504	4-40 OVAL X .250 LG. -T8	19553	10-12
C	TPGH-2	19506	4-40 X .250 LG. - T-10	19554	
INCB IND IFPC	TPGH-2	19074	M2.5 X .250 LG. - T-10	19554	
D	TPGB-3 TPGC-3	19508	4-40 F.H. X .250 LG. - T-8	19553	12-15
	TPGH-3	19507	4-40 F.H. X .250 LG. - T-10	19554	
E, ANSI	WCGT-0	19040	M2 X .4 I.S.O. X .135 LG. - T-6	19551	4-5
F, ANSI	WCGT-1	19041	M2 X .4 I.S.O. X .180 LG. - T-6	19551	10-12
G, ANSI	WCGT-2	19035	M2.5 X .45 I.S.O. X .220 LG. - T-7	19552	
H, ANSI	WCGT-3	19043	M4 X .7 I.S.O. X .315 LG. - T-15	19555	12-15
INCB IFPC ANSI	CCGT-21.51	19035	M2.5 X .45 I.S.O. X .220 LG. - T-7	19552	10-12
ANSI	CCGT-32.51	19070	M3.5 X .6 ISO X .315 LG. - T-15	19555	12-15
ANSI	CPGT-21.51	19035	M2.5 X .45 I.S.O. X .220 LG. - T-7	19552	10-12
ANSI	CPGT-32.51	19070	M3.5 X .6 ISO X .315 LG. - T-15	19555	12-15
ANSI	DCGT-21.51	19035	M2.5 X .45 I.S.O. X .220 LG. - T-7	19552	10-12
ANSI	DCGT-32.51	19070	M3.5 X .6 ISO X .315 LG. - T-15	19555	12-15
ANSI	TCGT-21.51	19035	M2.5 X .45 I.S.O. X .220 LG. - T-7	19552	10-12
ANSI	TCGT-32.51	19070	M3.5 X .6 ISO X .315 LG. - T-15	19555	12-15
ANSI	TPGT-21.51	19035	M2.5 X .45 I.S.O. X .220 LG. - T-7	19552	10-12
ANSI	TPGT-32.51	19070	M3.5 X .6 ISO X .315 LG. - T-15	19555	12-15
TH	CDCT-2	19501	1-72 OVAL X .090 LG. - T-6	19551	4-5
TH	TBEB-2	19503	2-56 OVAL X .110 LG. - T-7	19552	8-9
TH	TBEB-4	19504	4-40 OVAL X .250 LG. - T-8	19553	10-12
CHM	APLT	19043	M4 X .7 I.S.O. X .315 LG. - T-15	19555	12-15
PB	VPGT-2	19035	M2.5 X .45 I.S.O. X .220 LG. - T-7	19552	10-12
PB	XPGT-1	19041	M2 X .4 I.S.O. X .180 LG. - T-6	19551	10-12

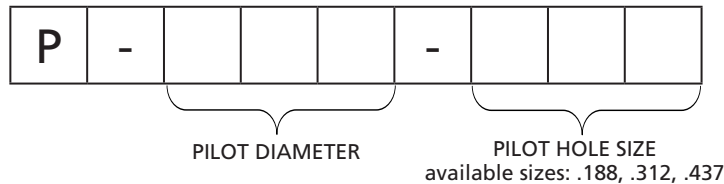
Ordering Information
PILOT

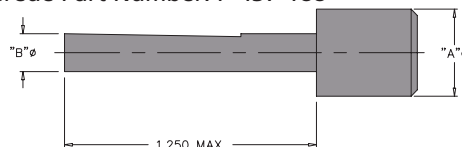

EXAMPLE: 7/16 pilot x 3/16 shank Everede Part Number: P-437-188

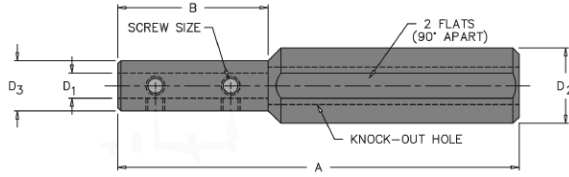

Price and availability available on request. Non-stock. Quick delivery item.



BORING BAR SLEEVES

EVEREDE PART NUMBER	D1	D2	B	A	D3	
	BAR DIA	SHANK DIA	BAR DEPTH	OAL	HEAD DIA	SCREW #
BBS-125/375	1/8	3/8	3/4	4	3/8	19220
BBS-125/500	1/8	1/2	3/4	4	3/8	19220
BBS-125/625	1/8	5/8	3/4	4	3/8	19220
BBS-125/750	1/8	3/4	3/4	5	3/8	19220
BBS-125/1000	1/8	1	3/4	6	3/8	19220
BBS-156/375	5/32	3/8	3/4	4	3/8	19220
BBS-156/500	5/32	1/2	3/4	4	7/16	19220
BBS-156/625	5/32	5/8	3/4	4	7/16	19220
BBS-156/750	5/32	3/4	3/4	5	7/16	19220
BBS-156/1000	5/32	1	3/4	6	7/16	19220
BBS-156/1250	5/32	1-1/4	3/4	8	7/16	19220
BBS-156/1500	5/32	1-1/2	3/4	8	7/16	19220
BBS-187/375	3/16	3/8	3/4	4	3/8	19231
BBS-187/500	3/16	1/2	3/4	4	7/16	19231
BBS-187/625	3/16	5/8	3/4	4	7/16	19231
BBS-187/750	3/16	3/4	3/4	5	7/16	19231
BBS-187/1000	3/16	1	3/4	6	7/16	19231
BBS-187/1250	3/16	1-1/4	3/4	8	7/16	19231
BBS-187/1500	3/16	1-1/2	3/4	8	7/16	19231
BBS-250/500	1/4	1/2	1	4	1/2	19251
BBS-250/625	1/4	5/8	1	4	5/8	19251
BBS-250/750	1/4	3/4	1	5	5/8	19251
BBS-250/1000	1/4	1	1	6	5/8	19251
BBS-250/1250	1/4	1-1/4	1	8	5/8	19251
BBS-250/1500	1/4	1-1/2	1	8	5/8	19251
BBS-312/625	5/16	5/8	1-1/4	4	5/8	19251
BBS-312/750	5/16	3/4	1-1/4	5	11/16	19251
BBS-312/1000	5/16	1	1-1/4	6	11/16	19251
BBS-312/1250	5/16	1-1/4	1-1/4	8	11/16	19251
BBS-312/1500	5/16	1-1/2	1-1/4	8	11/16	19251
BBS-375/625	3/8	5/8	1-1/2	4	5/8	19022
BBS-375/750	3/8	3/4	1-1/2	5	3/4	19022
BBS-375/1000	3/8	1	1-1/2	6	3/4	19022
BBS-375/1250	3/8	1-1/4	1-1/2	8	3/4	19022
BBS-375/1500	3/8	1-1/2	1-1/2	8	3/4	19022
BBS-500/750	1/2	3/4	2	5	3/4	19022
BBS-500/1000	1/2	1	2	6	1	19263
BBS-500/1250	1/2	1-1/4	2	8	1	19263
BBS-500/1500	1/2	1-1/2	2	8	1	19263
BBS-625/1250	5/8	1-1/4	2	8	1-1/8	19263
BBS-625/1500	5/8	1-1/2	2	8	1-1/8	19263
BBS-750/1250	3/4	1-1/4	2-1/2	8	1-1/8	19263
BBS-750/1500	3/4	1-1/2	2-1/2	8	1-1/8	19263

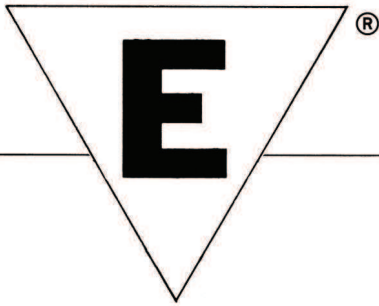

10° & 15° Standard Lathe and Production Boring Bars

100 - 200 - 300 - 500 Series Nos.

EVEREDE TOOL CO.®

ALL DIMENSIONS ARE IN INCHES UNLESS OTHERWISE NOTED.

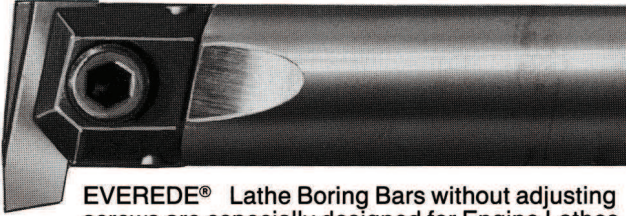

EVEREDE® Lathe Boring Bars without adjusting screws are especially designed for Engine Lathes

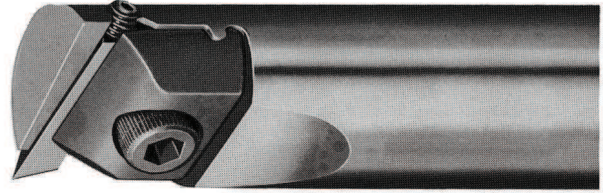

EVEREDE® Production Boring Bars are especially designed for Turret Lathes, and incorporate an adjusting screw behind the tool bit for quicker, fine adjustments.

LATHE BARS

TOOL BIT SIZE	BAR DIAMETER	LENGTH	BAR PART NO.
5/32	1 1/32 x 2*	6	220
	3/8	7	225
	7/16	7 5/8	230
	1/2	8 1/4	235
	9/16	8 3/4	240
1/4	5/8	9 1/2	245
	3/4	10	250
	7/8	11	255
	1	12	265
5/16	1 1/8	15	270
	1 1/4	17	275
	1 3/8	19	280
	1 1/2	22	285

*11/32 bar has 3/8" shank.

PRODUCTION BARS

TOOL BIT SIZE	BAR DIAMETER	LENGTH	BAR PART NO.
7/64	5/16*	6	315
	3/8M*	6	325
5/32	7/16	6	330
	1/2	6	335
	9/16	6	340
1/4	5/8	8	345
	3/4	8	350
	7/8	8	355
	1	8	365
5/16	1 1/8	10	370
	1 1/4	10	375
	1 3/8	10	380
	1 1/2	10	385

5/16 AND 3/8M TOOL ANGLE Q OF BAR IS 75°
ALL OTHER BARS ARE 80°

EVERY BAR INCLUDES ONE HSS BIT AND ONE ALLEN TYPE WRENCH; EXCEPT THE 7/64 BAR PROGRAM.

LATHE BAR SETS

SET NO.	BAR DIAMETERS INCLUDED	REFERENCE	
		BUSHING SET NO.	BORING BAR HOLDER NO.
200	1 1/32, 3/8, 7/16, 1/2, 9/16, 5/8, 3/4, 7/8, 1	3300	3030
200-A	1 1/32, 3/8, 7/16, 1/2, 9/16, 5/8, 3/4, 1	3300-A	3030
200-B	1 1/32, 3/8, 7/16, 1/2, 9/16, 5/8, 3/4	3200-B	3020
200-C	3/8, 1/2, 5/8, 3/4, 1	3300-C	3030
200-D	1 1/32, 7/16, 9/16, 5/8, 1	3300-D	3030
200-E	7/16, 9/16, 5/8, 1	3300-E	3030
200-F	3/8, 1/2, 5/8, 3/4	3200-F	3020
		3300-C	3030

• LATHE BAR SETS AVAILABLE WHILE SUPPLIES LAST

PRODUCTION BAR SETS

SET NO.	BAR DIAMETERS INCLUDED	REFERENCE	
		BUSHING SET NO.	BORING BAR HOLDER NO.
300	5/16, 3/8M, 7/16, 1/2, 9/16, 5/8, 3/4, 7/8, 1	3300-G	3080
300-A	5/16, 3/8M, 7/16, 1/2, 9/16, 5/8, 3/4, 1	3300-H	3080
300-B	5/16, 3/8M, 7/16, 1/2, 9/16, 5/8, 3/4	3200-A	3070
300-C	3/8M, 1/2, 9/16, 5/8, 3/4, 1	3300-H	3080
300-D	5/16, 7/16, 9/16, 5/8, 1	3300-J	3080
300-E	7/16, 9/16, 5/8, 1	3300-K	3080
300-F	3/8M, 1/2, 5/8, 3/4	3300-E	3080
		3200-F	3070
		3300-C	3080

• PRODUCTION BAR SETS AVAILABLE WHILE SUPPLIES LAST

MIDGET BORING BAR SET

All Shank Dia. 3/8"



TOOL BIT SIZE	SET NO.	BAR DIA.	BAR LENGTH	OAL	BAR PART NO.
7/64	100	7/32	1 7/16	6	105
		17/64	1 5/8	6	110
		5/16	1 3/4	6	115
		3/8M*	—	6	125

100 SET INCLUDES 9210 BOX

REF: TOOL ANGLE 75° TO Q OF BAR

USED EXTENSIVELY WITH BORING BAR HOLDER NO. 3010

• MIDGET BORING BAR SETS AVAILABLE WHILE SUPPLIES LAST

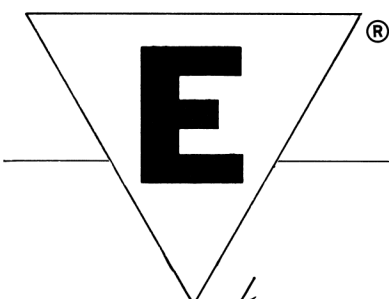

30° Boring Bars

1500 - 1600 Series Nos.

EVEREDE TOOL CO.®

ALL DIMENSIONS ARE IN INCHES UNLESS OTHERWISE NOTED.

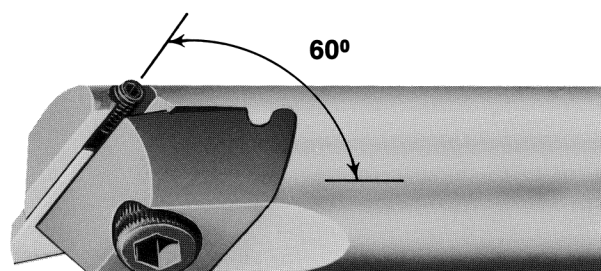
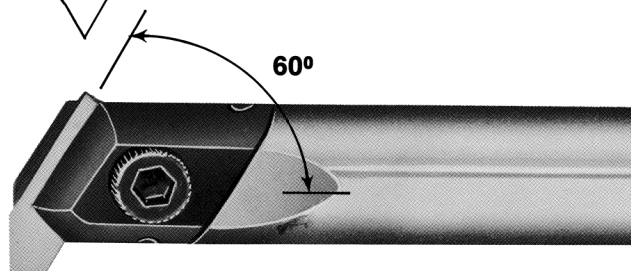

Basically Designed for Boring to a Shoulder

EVEREDE® Lathe Boring Bars without adjusting screws are especially designed for Engine Lathes

EVEREDE® Production Boring Bars are especially designed for Turret Lathes, and incorporate an adjusting screw behind the tool bit for quicker, fine adjustments.

30° LATHE BARS

TOOL BIT SIZE	BAR DIA.	BAR LENGTH	LATHE BAR PART NO.
	3/8	7	1525
	7/16	7 5/8	1530
	1/2	8 1/4	1535
	9/16	8 3/4	1540
	5/8	9 1/2	1545
	3/4	10	1550
	7/8	11	1555
	1	12	1565
	1 1/8	15	1570
	1 1/4	17	1575
	1 3/8	19	1580
	1 1/2	22	1585

30° PRODUCTION BARS

TOOL BIT SIZE	BAR DIA.	BAR LENGTH	PRODUCTION BAR PART NO.
	3/8M	7	1625
	7/16	7 5/8	1630
	1/2	8 1/4	1635
	9/16	8 3/4	1640
	5/8	9 1/2	1645
	3/4	10	1650
	7/8	11	1655
	1	12	1665
	1 1/8	15	1670
	1 1/4	17	1675
	1 3/8	19	1680
	1 1/2	22	1685

30° LATHE & 30° PRODUCTION BAR SETS

LATHE SET NO.	BAR DIAMETERS INCLUDED	PROD. SET NO.	BAR DIAMETERS INCLUDED	REFERENCE	
				BUSHING SET NO.	BORING BAR HOLDER NO.
1500-A	3/8, 7/16, 1/2, 9/16, 5/8, 3/4, 7/8, 1	1600-A	3/8, 7/16, 1/2, 9/16, 5/8, 3/4, 7/8, 1	3300	3030
1500-B	3/8, 7/16, 1/2, 9/16, 5/8, 3/4	1600-B	3/8, 7/16, 1/2, 9/16, 5/8, 3/4	3200-B	3020
				3300-A	3030
1500-C	3/8, 1/2, 5/8, 3/4, 1	1600-C	3/8, 1/2, 5/8, 3/4, 1	3300-C	3030
1500-D	3/8, 7/16, 9/16, 5/8, 1	1600-D	3/8, 7/16, 9/16, 5/8, 1	3300-D	3030
1500-E	7/16, 9/16, 5/8, 1	1600-E	7/16, 9/16, 5/8, 1	3300-E	3030
1500-F	3/8, 1/2, 5/8, 3/4	1600-F	3/8, 1/2, 5/8, 3/4	3200-F	3020
				3300-C	3030

EVERY BAR INCL. ONE H.S.S. BIT, ONE ALLEN TYPE WRENCH. REF: TOOL ANGLE 60° TO C OF BAR.

● 30 DEGREE LATHE & PRODUCTION BAR SETS AVAILABLE WHILE SUPPLIES LAST

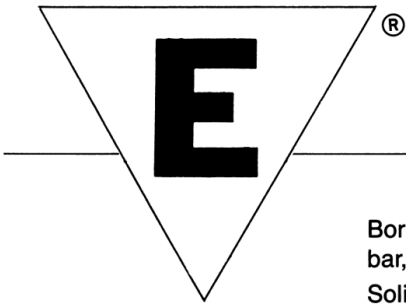

Solid Carbide Boring Bars

1600C - 1600CL - 1800 - 1800L Series Nos.

EVEREDE TOOL CO.®

ALL DIMENSIONS ARE IN INCHES UNLESS OTHERWISE NOTED.

Boring bars with solid carbide shanks have a modulus of elasticity three times stiffer than a steel bar, eliminating taper in bored holes due to deflection of the boring bar.

Solid carbide bars permit boring deeper and truer holes, resulting in higher production with longer tool life, closer tolerances and better finishes.

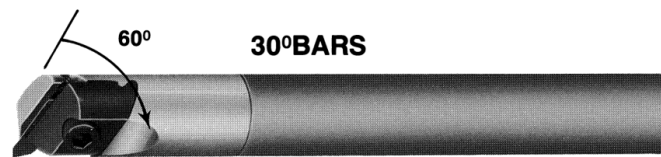
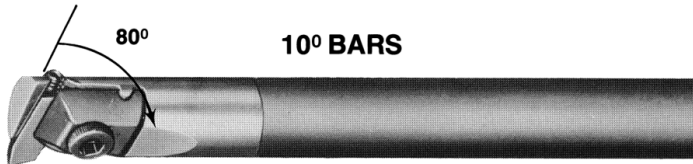

Same as standard production boring bars (No. 300 series with adjustment screw) except with a solid carbide shank for use in boring deep holes where maximum rigidity is essential.

Same as standard production boring bars (No. 1600 series with adjustment screw) except with a solid carbide shank used basically in boring to a shoulder.

TOOL BIT SIZE	BAR DIA	STANDARD LENGTH	BAR PART NO. 10° BAR**	BAR PART NO. 30° BAR***	LONG LENGTH	BAR PART NO. 10° BAR**	BAR PART NO. 30° BAR***
$\frac{7}{64}$	$\frac{1}{4}$ *	6	1808	1608C	8	1808L	1608CL
	$\frac{5}{16}$	6	1815	1615C	8	1815L	1615CL
	$\frac{3}{8}$ Midget	6	1825	1625C	8	1825L	1625CL
$\frac{5}{32}$	$\frac{7}{16}$	6	1830	1630C	8	1830L	1630CL
	$\frac{1}{2}$	6	1835	1635C	8	1835L	1635CL
	$\frac{9}{16}$	6	1840	1640C	8	1840L	1640CL
	$\frac{5}{8}$	8	1845	1645C	11	1845L	1645CL
	$\frac{3}{4}$	8	1850	1650C	11	1850L	1650CL
	$\frac{7}{8}$	8	1855	1655C	11	1855L	1655CL
	1	8	1865	1665C	11	1865L	1665CL
	$1\frac{1}{8}$	10	1870	1670C	14	1870L	1670CL
	$1\frac{1}{4}$	10	1875	1675C	14	1875L	1675CL
	$1\frac{3}{8}$	10	1880	1680C	14	1880L	1680CL
	$1\frac{1}{2}$	10	1885	1685C	14	1885L	1685CL

* $\frac{1}{4}$ Bar does not have adjusting screw.

** REF: Tool Angle 80° to ϕ of Bar

*** REF: Tool Angle 60° to ϕ of Bar

NOTE:

- Special diameters and lengths available.
- Can be furnished in heavy metal (high density tungsten alloy)

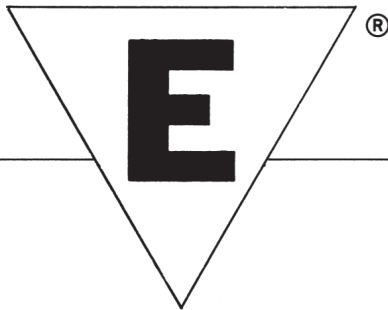

90° Grooving Bars

1300 Series Nos.

EVEREDE TOOL CO.®

ALL DIMENSIONS ARE IN INCHES UNLESS OTHERWISE NOTED.

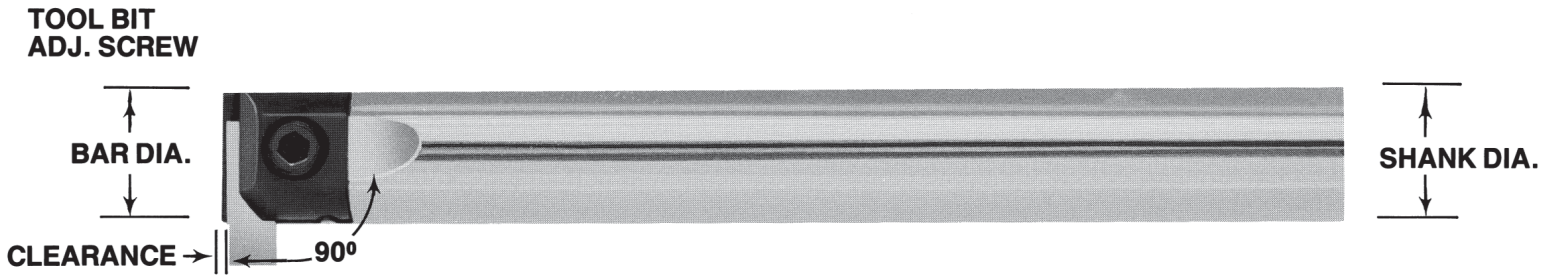

FOR: YOUR INSIDE DIAMETER GROOVING NEEDS O-RINGS — SNAP RINGS — WIRE RINGS — SQUARE GROOVES — RADIUS GROOVES — SPECIAL MULTI-STEP GROOVES

TOOL BIT SIZE	BAR NUMBER	SHANK DIA.	BAR DIA.	BAR LENGTH	OVERALL LENGTH	CLEAR-ANCE	TOOL BIT ADJ. SCR.	TOOL BITS			
								H.S. STEEL		CARBIDE	
								NUMBER	LENGTH	NUMBER	LENGTH
7/64	1305	3/8	7/32	17/16	6	3/32	NO	20005 *	5/16	25020	7/16
	1310	3/8	17/64	15/8	6	3/32	NO	20010 *	3/8	25020	7/16
	1315	3/8	5/16	13/4	6	3/32	NO	20015 *	7/16	25020	7/16
	1325M	3/8	3/8	—	6	3/32	NO	20020 *	17/32	25020	7/16
5/32	1330	7/16	7/16	—	8	1/8	NO	20105	17/32	25110	1/2
	1335	1/2	1/2	—	8	1/8	NO	20110	19/32	25110	1/2
	1340	9/16	9/16	—	8	1/8	YES	20115	11/16	25120	5/8
	1345M	5/8	5/8	—	10	1/8	YES	20120	3/4	25120	5/8
1/4	1350	3/4	3/4	—	10	11/64	YES	20205	13/16	25205	3/4
	1355	7/8	7/8	—	10	11/64	YES	20210	31/32	25210	7/8
	1365	1	1	—	10	11/64	YES	20215	19/32	25215	11/8

* NO LONGER AVAILABLE

**TOOL BIT SPECIALS:
SEND US YOUR REQUIREMENTS**

ADD 'C' TO PART NO. FOR CARBIDE SHANK.
EXAMPLE: 1335C

PRICES & DELIVERY FURNISHED ON REQUEST



SNAP RING

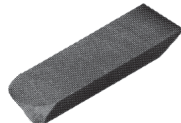

RAD. GROOVE

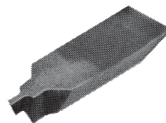

STEP GROOVE

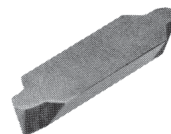

O-RING & CHAMF.

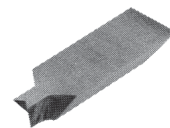

DOVETAIL

**SINGLE or DOUBLE END:
TYPICAL TOOL BIT SHAPES THAT CAN BE FURNISHED**

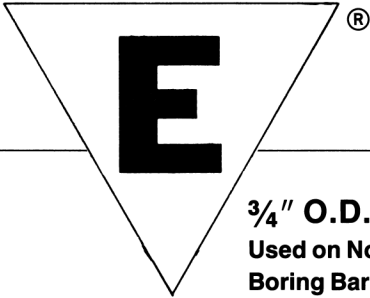

Bushing Sets

3200 - 3300 Series Nos.

Used With Boring and
Boring Bar Holders

EVEREDE TOOL CO.®

ALL DIMENSIONS ARE IN INCHES UNLESS OTHERWISE NOTED.

3/4" O.D. BUSHINGS 2 15/16" LG.

Used on No. 3020 or No. 3070
Boring Bar Holders

BUSHING SET NO.	USED WITH BORING BAR SET NO.	INDIV. BUSH. PART NO.	BAR DIA. OR BUSHING I.D.						
			5/16	3/8	7/16	1/2	9/16	5/8	
			3215	3225	3230	3235	3240	3245	
3200-A	300-B		X	X	X	X	X	X	X
3200-B	200-B, 1500-B			X	X	X	X	X	X
3200-F	200-F, 300-F, 1500-F			X		X			X

NOTE: Bushing not required for 3/4" bar — used directly in barrel of Boring Bar Holder.

● BUSHING SETS AVAILABLE WHILE SUPPLIES LAST

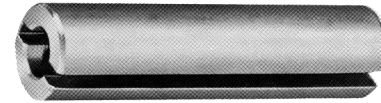

1" O.D. BUSHINGS 3 1/2" LG

Used on No. 3030 or No. 3080
Boring Bar Holders

BUSHING SET NO.	USED WITH BORING BAR SET NO.	INDIV. BUSH. PART NO.	BAR DIA. OR BUSHING I.D.							
			5/16	3/8	7/16	1/2	9/16	5/8	3/4	7/8
			3315	3325	3330	3335	3340	3345	3350	3355
3300	200, 1500-A			X	X	X	X	X	X	X
3300-A	200-A, 200-B, 1500-B			X	X	X	X	X	X	
3300-C	200-C, 200-F, 300-F, 1500-C, 1500-F			X		X		X	X	
3300-D	200-D, 1500-D			X	X		X	X		
3300-E	200-E, 300-E, 1500-E				X		X	X		
3300-G	300		X	X	X	X	X	X	X	X
3300-H	300-A, 300-B		X	X	X	X	X	X	X	
3300-J	300-C			X		X	X	X	X	
3300-K	300-D		X		X		X	X		

NOTE: Bushing not required for 1" bar — used directly in barrel of Boring Bar Holder.

● BUSHING SETS AVAILABLE WHILE SUPPLIES LAST

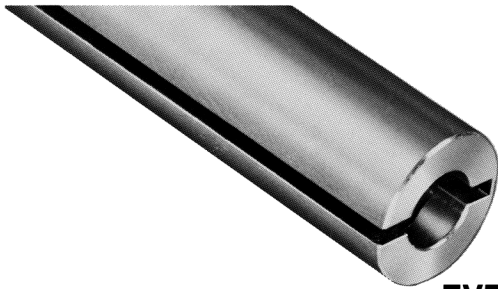

1 1/2" O.D. BUSHINGS

Used on No. 3035 or No. 3085
Boring Bar Holders
3 1/2" LG

BAR DIA. OR BUSHING I.D.	INDIV. BUSH. PART NO.		
	1 1/8	1 1/4	1 3/8
	3370	3375	3380

NOTE: Bushing not required for 1 1/2" bar — used directly in large barrel of Boring Bar Holder.

EVEREDE® Holders, Barrels & Bushings in Use

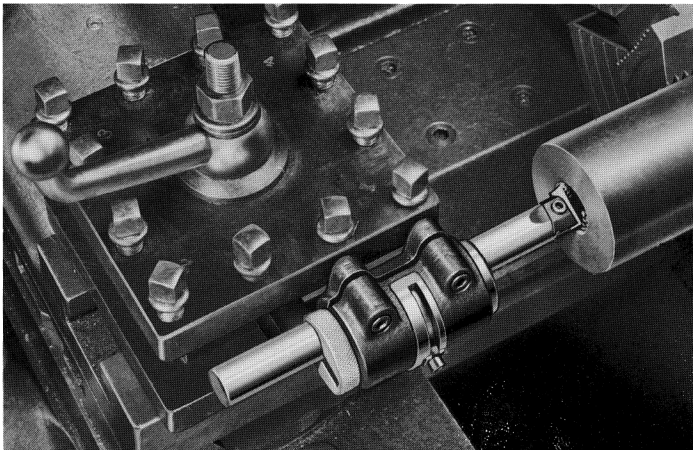

TURRET LATHE

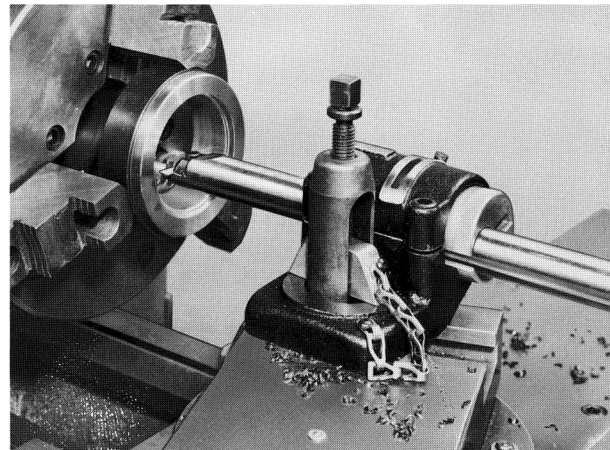

ENGINE LATHE



Tool Bits

20000, 25000 Series Nos.

EVEREDE TOOL CO.®

ALL DIMENSIONS ARE IN INCHES UNLESS OTHERWISE NOTED.

- UNSHARPENED FOR ALL BARS
- SHARPENED 60° THREADING BITS FOR 10° & 15° STANDARD BARS
- UNSHARPENED TOOL BITS (LONG LENGTH)
- THROWAWAY FOR ALL BARS
- SHARPENED FOR 30° BARS

Only 5 different sizes for bars 7/32" to 3". Unsharpened bits can be square shoulder ground or lead angle ground depending upon job and clearances required. Long length resharpening to provide versatility for different tool geometry to suit material to be cut. All items are stocked.

TOOL BIT SIZE	FOR BORING BAR DIAMETERS	LATHE BARS				PRODUCTION BARS			
		HIGH SPEED STEEL		SOLID CARBIDE*		HIGH SPEED STEEL		SOLID CARBIDE*	
		LENGTH	TOOL BIT PART NO.	LENGTH	TOOL BIT PART NO.	LENGTH	TOOL BIT PART NO.	LENGTH	TOOL BIT PART NO.
	7/32	5/16	20005 *	7/16	25020	—	—	—	—
	17/64	3/8	20010 *	7/16	25020	—	—	—	—
	5/16	7/16	20015 *	7/16	25020	3/8	20010	7/16	25020
	3/8 Midget	17/32	20020 *	7/16	25020	7/16	20015	7/16	25020
	11/32 & 3/8	17/32	20105	1/2	25110	—	—	—	—
	7/16	19/32	20110	1/2	25110	17/32	20105	1/2	25110
	1/2	11/16	20115	5/8	25120	19/32	20110	5/8	25120
	9/16	3/4	20120	5/8	25120	11/16	20115	5/8	25120
	435 Bar	3/4	20120	5/8	25120	—	—	—	—
	Jig Ext. Bar	3	20180	—	—	—	—	—	—
Lathe Ext. Bar	5	20190	—	—	—	—	—	—	
	5/8	13/16	20205	3/4	25205	13/16	20205	3/4	25205
	3/4	31/32	20210	7/8	25210	13/16	20205	7/8	25210
	7/8	19/32	20215	1 1/8	25215	31/32	20210	7/8	25210
	15/16	19/32	20215	1 1/8	25215	—	—	—	—
	1	19/32	20215	1 1/8	25215	19/32	20215	1 1/8	25215
	1 1/8	1 1/2	20305	1 1/4	25305	1 1/2	20305	1 3/8	25310
	1 1/4	1 5/8	20310	1 3/8	25310	1 1/2	20305	1 3/8	25310
	1 3/8	1 3/4	20315	1 3/8	25310	1 5/8	20310	1 3/8	25310
	1 1/2	1 7/8	20320	1 3/4	25320	1 3/4	20315	1 3/4	25320
	1 3/4	2 1/4	20430	2	25427	—	—	—	—
	460 Bar	2 1/4	20430	2	25427	—	—	—	—
	475 Bar	3	20445	3	25447	—	—	—	—

*Available while supplies last.

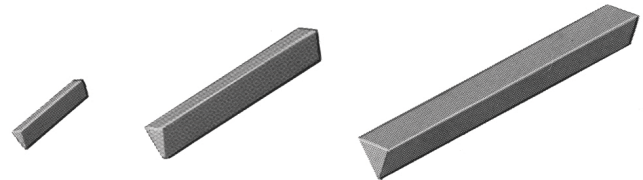

PLEASE ORDER BY TOOL BIT NUMBER

- SHARPENED 60° THREADING BITS FOR 10° - 15° STANDARD BARS

TOOL BIT SIZE	FOR BORING BAR DIAMETERS	HIGH SPEED STEEL		SOLID CARBIDE*	
		LENGTH	TOOL BIT PART NO.	LENGTH	TOOL BIT PART NO.
	7/32 Thru 3/8 Midget	1/2	20021	7/16	25021
	11/32 Thru 9/16	9/16	20111	1/2	25111
	5/8 Thru 1	15/16	20211	7/8	25211
	1 1/8 Thru 1 1/2	1 1/2	20306	1 1/4	25306

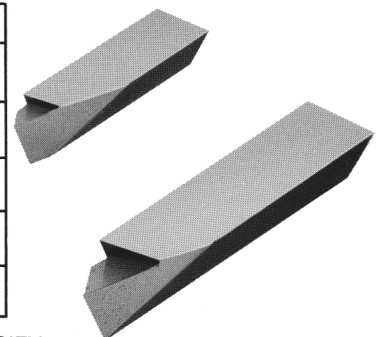

* SOLID CARBIDE BITS AVAILABLE IN APPLICATION CLASS C-2, C-4, C-6 AND C-8 — PLEASE SPECIFY CLASS REQUIRED OR MATERIAL TO BE CUT.

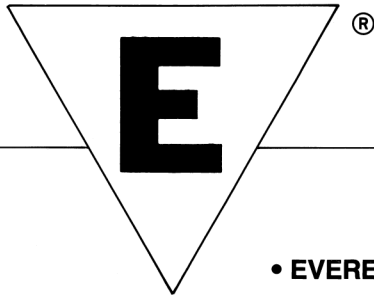

Tool Bits

20000, 25000 Series Nos.

EVEREDE TOOL CO.®

ALL DIMENSIONS ARE IN INCHES UNLESS OTHERWISE NOTED.

• EVEREDE® THROW-AWAY INSERTS . . .

Increase range of boring bar diameters. Only EVEREDE® offers throw-away inserts for use in boring bars from 7/32" to 1 1/2" diameter inclusive.

Reduce insert inventory. Just 4 sizes are necessary to provide cutting edges for all boring bar diameters in this 7/32" to 1 1/2" range.

Receive larger quantity discounts. Since less insert sizes are required, you can combine many small orders for various bars into fewer — but larger — orders.

Achieve greater versatility. Only EVEREDE® offers 4 different sizes of nose radii for each of 4 different sizes of throw-away inserts — at no extra cost.

Increase productivity. Now you can economically bore at high-velocity speeds. Both ends of the tool bits are pre-sharpened.

Use heavy cuts and fast feeds. Our unique boring bar — throw-away insert combination provides the same chip clearance possible with a grindable insert.

Get immediate delivery. All EVEREDE® inserts are available from stock in the various application classes and every size.

PRE-SHARPENED THROW-AWAY CARBIDE

TOOL BIT SIZE	FOR BORING BAR DIAMETERS	10° & 15° BAR TOOL BIT LENGTH	10° & 15° BAR TOOL BIT PART NO.
7/64 ▼	7/32, 17/64, 5/16, & 3/8 M	1/4	25005
5/32 ▼	11/32, 3/8, 7/16, 1/2, & 9/16	5/16	25115
1/4 ▼	5/8, 3/4, 7/8, 15/16, & 1	1/2	25235
5/16 — ▼	1 1/8, 1 1/4, 1 3/8, & 1 1/2	9/16	25345

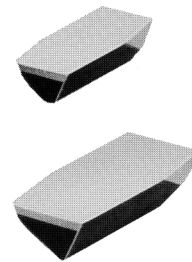

Nose Radii: .005, .010, .020, .030 Application Classes: C-2, C-4, C-6, C-8
When Ordering: Please specify Part no., Nose Radii, and Application Class desired.
Example: 25005 — 10 — C-6

• SHARPENED TOOL BITS FOR 30° BARS Preformed Triangular H.S.S. or Solid Carbide FROM STOCK

TOOL BIT SIZE	FOR BORING BAR DIAMETERS	HIGH SPEED STEEL		SOLID CARBIDE*	
		LENGTH	TOOL BIT PART NO.	LENGTH	TOOL BIT PART NO.
7/64 ▼	7/32, 17/64, 5/16, 3/8 M	3/8	20012	15/32	25012
5/32 ▼	3/8, 7/16, 1/2 & 9/16 DIA.	9/16	20112	15/32	25112
1/4 ▼	5/8, 3/4, 7/8 & 1 DIA.	15/16	20212	7/8	25212
5/16 — ▼	1 1/8, 1 1/4, 1 3/8 & 1 1/2 DIA.	1 1/16	20312	1 3/8	25312

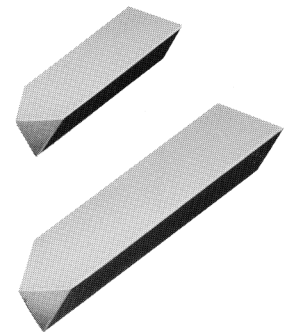

*SOLID CARBIDE BITS AVAILABLE IN APPLICATION CLASS C-2, C-4, C-6 AND C-8 — PLEASE SPECIFY CLASS REQUIRED OR MATERIAL TO BE CUT.

PLEASE ORDER BY TOOL BIT NUMBER

EVEREDE® Tungsten Carbide Grade Selection Chart

To Machine:
Cast Iron • Aluminum • Brass • Graphite • Kevlar • Other Composite Material or Non-Ferrous Metals • Austenitic Stainless Steel (Type 300 & 200B-3 - Non Magnetic)

To Machine:
Steel & Steel Alloys or Other Ferrous Metals
Ferritic & Martensitic Stainless Steel (Type 400 - Magnetic)

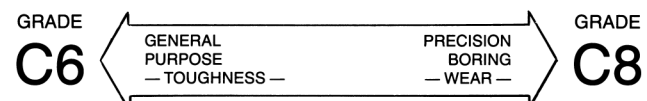
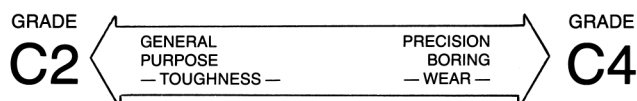

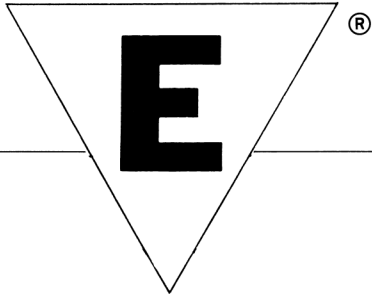

Replacement Parts / All EVEREDE Boring Bars

EVEREDE TOOL CO.®

ALL DIMENSIONS ARE IN INCHES UNLESS OTHERWISE NOTED.

BORING BAR DIAMETER	CAPS OR CLAMPS FOR			SOC. HD. CAP SCR. OR CLAMP SCREW	FOR PRODUCTION TYPE BARS ONLY TOOL BIT ADJUSTMENT SCREW
	MIDGET & 10° & 15° BARS	30° BARS	90° BARS		
	PART NO.	PART NO.	PART NO.	PART NO.	PART NO.
$\frac{7}{32}$	2005	2105	2205	19002	—
$\frac{17}{64}$	2010	2110	2210	19004	—
$\frac{5}{16}$	2015	2115	2215	19004	19210
$\frac{3}{8}M$	2026	2126	2226	19005	19210
$\frac{11}{32}$	2020	—	—	19005	—
$\frac{3}{8}$	2025	2125	—	19005	—
$\frac{7}{16}$	2030	2130	2230	19005	19210
$\frac{1}{2}$	2035	2135	2235	19006	19210
$\frac{9}{16}$ Dia. & #1100 SET OFFSET BAR	2040	2140	2240	19142	19210
JIG EXTENSION BAR	—	—	—	—	19242
LATHE EXTENSION BAR	—	—	—	—	19242
$\frac{5}{8}$	2045	2145	2245M	19151	19240
$\frac{3}{4}$	2050	2150	2250	19153	19240
$\frac{7}{8}$	2055	2155	2255	19164	19240
$\frac{15}{16}$	2060	—	—	19164	—
1	2065	2165	2265	19164	19240
$1\frac{1}{8}$	2070	2170	—	19172	19251
$1\frac{1}{4}$	2075	2175	—	19172	19251
$1\frac{3}{8}$	2080	2180	—	19172	19251
$1\frac{1}{2}$	2085	2185	—	19172	19251
$1\frac{3}{4}$	2087	—	—	19172 (2)	—
#1400 SET OFFSET BAR	2071	—	—	19172 (1)	—
#1200 SET OFFSET BAR	2087	—	—	19172 (1)	—
2 & $2\frac{1}{4}$	2087	—	—	19172 (2)	—
$2\frac{1}{2}$	2087	—	—	19172 (2)	—
3 & OVER	2087	—	—	19172 (2)	—

***TOOL ANGLE REFERENCE:**

MIDGET BARS ($\frac{7}{32}$ Dia. thru $\frac{3}{8}M$) — Clamp Bit at 75° to \angle of Bar
 10° & 15° BARS (Lathe, Offset, Jig and Prod.) — Clamp Bit at 80° to \angle of Bar
 30° BARS (Lathe and Jig) — Clamp Bit at 60° to \angle of Bar
 90° BARS — Clamp Bit at 90° to \angle of Bar

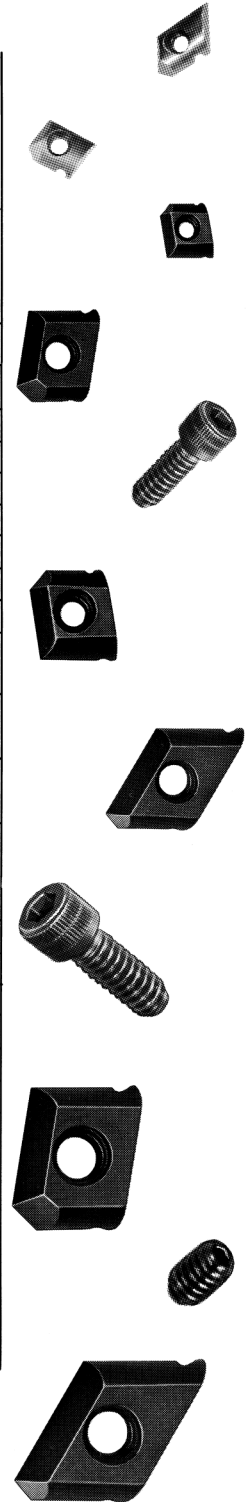



Series RSF

BODY DIAMETER
0.25" TO 1.25"

PILOTS DIAMETER
0.094" TO 0.500"



REVERSE SPOT FACERS (Series RSF)

BODIES		
Part #	Diameter	Pilot Hole
RSF-250-094	1/4	3/32
RSF-250-125	1/4	1/8
RSF-312-094	5/16	3/32
RSF-312-125	5/16	1/8
RSF-312-156	5/16	5/32
RSF-375-125	3/8	1/8
RSF-375-156	3/8	5/32
RSF-375-188	3/8	3/16
RSF-437-125	7/16	1/8
RSF-437-156	7/16	5/32
RSF-437-188	7/16	3/16
RSF-500-188	1/2	3/16
RSF-500-250	1/2	1/4
RSF-562-188	9/16	3/16
RSF-562-250	9/16	1/4
RSF-625-188	5/8	3/16
RSF-625-250	5/8	1/4
RSF-625-312	5/8	5/16
RSF-687-250	11/16	1/4
RSF-687-312	11/16	5/16
RSF-750-250	3/4	1/4
RSF-750-312	3/4	5/16
RSF-750-375	3/4	3/8
RSF-875-312	7/8	5/16
RSF-875-375	7/8	3/8
RSF-1.000-312	1	5/16
RSF-1.000-375	1	3/8
RSF-1.000-500	1	1/2
RSF-1.250-375	1 1/4	3/8
RSF-1.250-500	1 1/4	1/2

PILOTS	
Part #	Pilot Dia
PB-094-6	3/32
PB-125-6	1/8
PB-156-6	5/32
PB-187-6	3/16
PB-250-6	1/4
PB-312-6	5/16
PB-375-6	3/8
PB-500-6	1/2

Ordering Information

RSF-3750-1250

Reverse Spot Facer	Body Diameter	Pilot Hole
--------------------	---------------	------------

- Made from HSS
- Standard Radius .030"
- Specials and other radii available upon request
- Pilots are 6" OAL, other sizes available upon request

REVERSE COUNTERSINKS

Series RCS



REVERSE COUNTERSINKS (Series RCS)

Ordering Information

RCS-31-1-156

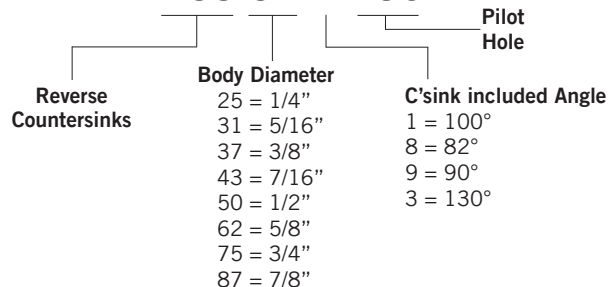

Specials and other radii available upon request		Other Pilot sizes available upon request
---	--	--

Custom Tooling



Indexable

Modified Standards and custom:

Countersinks, chamfer mills, counter bores, boring bars.

Complete Custom Tooling:

Hollow mills, plunge mills and endmills.

Back boring bars, profile bars, groove bars, and features/form generating tooling.

Multi-operation and /or multi-step tooling, porting tools, spade drills.

Engineering Support:

Made to your engineering drawings.

Utilizing special and/or ISO standard inserts.

Engineered from piece part drawings, samples or existing tool drawings.

Everede Advantages

- Fast Quote response time
- Timely approval print process
- Quick deliveries

The Right Solution from One Source



Just say
"Ever-Ready"

 **EVEREDE TOOL COMPANY**
Manufacturing quality cutting tools since 1932

Just say "Ever-Ready"



Everede - Exclusive Marketer and Importer for Nine9 & Dümmel

Distributed by

